



**DIGITAL
PROGRAMMABLE
ALGORITHM
SYNTHESIZER**

● **OWNER'S MANUAL**

●

INTRODUCTION

Thank you for choosing the Yamaha DX1 Digital Programmable Algorithm Synthesizer.

The DX1 is a fully digital synthesizer incorporating the state-of-the-art technology including Yamaha's superb FM tone generator system. The DX1 offers the highest levels of performance, programmability and sound quality.

Please be sure to read this manual thoroughly before you use your DX1 to ensure many hours of trouble-free use.

FEATURES

- * Microcomputer-based operation offers a tremendous range of functions in an easy-to-use system. All functions are selected via light-touch electronic buttons, and data entry is carried out via buttons or a slider control.
- * Data is displayed on the LCD or LED graphic displays, making all pertinent parameters visible during programming. The LED graphic display in particular offers simultaneous readout of many parameters making it easier to check overall program status.
- * 64 (2 channels x 32) voice memory. 256 pre-programmed voices are provided in external ROM memory cartridges (64 of which are the same as the voices pre-programmed in the DX1 internal memory). Voices from the two voice channels can be used independently, or combined as needed.
- * The DX1 is also equipped with a 64 voice performance memory which can store combinations of voice and effect (modulation wheel, foot controller, etc.) parameters for easy one-touch selection. A pre-programmed 64 voice ROM cartridge is provided.
- * Memory data can be stored in optional RAM cartridges, permitting creation of an original voice library.
- * Full editing facilities permit alteration of existing voice data.
- * Totally new voices can be created using the initialize memory function.
- * The FM tone generator is a revolutionary system which is totally programmable and permits creating voices with a natural, irregular harmonic structure. Two tone generator channels--A and B--are provided. Each features a 6-operator 32-algorithm system. Each operator is fully programmable permitting limitless voice creation.
- * A new 8-parameter envelope generator system permits programming complex envelope waveforms for unprecedented versatility. An independent envelope generator is provided for each operator, as well as a separate pitch envelope generator.
- * The DX1 features programmable key velocity sensitivity function which enables control of volume and timbre via key pressure. Further, the keyboard has been specially designed to respond to the player's touch just like a high quality acoustic piano.
- * The keyboard scaling function enables natural volume and timbre scaling, and alteration of the EG response through the keyboard range.
- * The DX1 provides a rich variety of effects such as pitch bend, portamento/glissando, EG bias and LFO modulation. These can be operated by means of four controllers: a modulation wheel, foot controller, keyboard after-touch response, and a unique breath controller (optional).
- * The DX1 is equipped with a MIDI interface. This permits control and transfer of data between the DX1 and another MIDI compatible keyboard, MIDI computer, sequencer, or other MIDI equipment.

CAUTIONS

* Location

Avoid placing the DX1 in the following locations:

- * By windows or in direct sunlight.
- * By heaters or places subject to extremes of heat or cold.
- * Dusty places.
- * Places subject to vibration.

* Power

- * Make sure that your DX1 is properly adjusted to accept the AC mains voltage and frequency in your area. Do not under any circumstances connect the DX1 to any other type of power source.
- * Remove the AC plug from the socket during thunderstorms.

* Connections

- * Read the section in the manual on terminals and connections carefully, and be sure to connect the equipment correctly.
- * In order to avoid speaker damage make sure that all power switches to related equipment are OFF before connecting.

* Operating and Transportation

- * Do not apply unnecessary force to the switches and knobs.
- * In order to avoid broken cables and shorts, unplug all connection cables from the socket whenever you move the equipment. Always unplug connectors by gripping the plug, not the cord. Unplug the DX1 if you are not planning to use it for some time.

* Warranty Procedures

- * Make sure you carry out the warranty procedures at the shop where you purchase your DX1. If the warranty certificate is not filled out properly, you will be required to pay a charge for servicing even though your machine is still within the warranty period.
- * Keep this manual and your warranty certificate in a safe place.

* Other Appliances

- * Your DX1 contains digital circuitry. If it is used too close to radios, TVs or related equipment interference may result. Make sure that your DX1 is sufficiently separated from other equipment.

CONTENTS

CHAPTER 1	DX1 OUTLINE/THE FM VOICE GENERATOR SYSTEM	4
1-1	DX1 System Outline	4
1-2	THE FM TONE GENERATOR	4
CHAPTER 2	DX1 FEATURES AND FUNCTIONS	6
2-1	The 4 Modes of the DX1	6
2-2	Control Panel (fig. 8)	6
2-3	Connection Terminals	9
CHAPTER 3	PLAY mode/PERFORMANCE MEMORY	11
3-1	PERFORMANCE MEMORY & VOICE MEMORY	11
3-2	Calling Memory Data	12
3-3	STORE/MOVING MEMORY	14
CHAPTER 4	EDIT mode/VOICE PARAMETERS	18
4-1	The EDIT Mode	18
4-2	The Voice Parameter Buttons Below the LED Display	21
4-3	PERFORMANCE MEMORY/FUNCTION SECTION VOICE PARAMETERS	27
CHAPTER 5	FUNCTION MODE/EFFECTS AND OTHER FUNCTIONS	31
5-1	The 3 function of the FUNCTION mode	31
5-2	The FUNCTION mode control process	31
5-3	PERFORMANCE MEMORY PARAMETERS	35
5-4	MEMORY MANAGEMENT	42
5-5	MIDI INFO. CONTROL (fig. 78)	47
CHAPTER 6	STORE MODE/DATA MEMORY STOCK	52
6-1	3 Varieties of the STORE Function	52
6-2	Application of STORE ALL	53
6-3	STORE VOICE APPLICATIONS	54
6-4	STORE PERFORMANCE APPLICATION	55
CHAPTER 7	VOICE INITIALIZE/PROGRAMMING A NEW VOICE	57
7-1	Programming a voice from the INITIALIZE MEMORY state	57
7-2	ENTERING VOICE PARAMETER DATA	58
7-3	ENTERING THE PERFORMANCE MEMORY PARAMETERS	59
CHAPTER 8	USING THE MIDI TERMINALS	61
8-1	ABOUT THE MIDI TERMINALS	61
8-2	MIDI SYSTEM CONNECTIONS AND OPERATIONS	62
CHAPTER 9	FM TONE GENERATOR THEORY	67
9-1	Approaching the FM Tone Generator	67
9-2	FM Tone Generator Theory	69
CHAPTER 10	GENERAL SPECIFICATIONS	72
CHAPTER 11	BLOCK DIAGRAM	73

DX1 OUTLINE/THE FM VOICE GENERATOR SYSTEM

1-1 DX1 System Outline

The block diagram in figure 1 roughly outlines the DX1 system. It consists of four main sections:

- (1) CONTROL PANEL
- (2) FM TONE GENERATOR
- (3) DIGITAL EG
- (4) KEYBOARD

The simplicity of the system has been made possible because it functions mostly on digital principles. Based on the block diagram in figure 1, we'll roughly describe each section.

(1) CONTROL PANEL

Almost all controls are logic control switches. Other features on this remarkably simple panel include a graphic LED display, an alphanumeric LCD display, a few linear controls and controller wheels.

(2) FM TONE GENERATOR

In addition to pitch, timbre and level programming capability, these sophisticated tone generators are also capable of generating noise components like those found in natural sounds and acoustic instruments. They offer unprecedented precision and versatility in voice creation.

(3) DIGITAL EG

This system permits programming time-based variations of pitch, timbre and level. Because it is a digital system, the EG curve can be precisely programmed in numeric form. Further, the digital EG has 8 variable parameters permitting exceptionally versatile EG curve generation.

(4) KEYBOARD

This is a 73-key, 32-note polyphonic keyboard with three touch functions: key velocity sensitivity (initial touch), after touch, and key individual after touch. This

offers greatly expanded expression capability. Further, the keyboard offers a precision weighted-return action for the most natural overall keyboard response.

1-2 THE FM TONE GENERATOR

The Yamaha FM tone generator permits precise control over voice pitch, timbre and level. The following is a brief description of FM tone generator principles. See Chapter 9 for a more technical explanation of FM tone generator theory.

What is FM?

FM stands for Frequency Modulation, just as it does when used to describe an "FM" station or radio broadcast.

The term "modulation" means, basically, to superimpose one signal on top of another signal. In other words, a signal of a given pitch may be used to "modulate" a signal of another pitch. The vibrato effect is an example of a low-frequency signal (the vibrato) modulating a high-frequency signal (the note to which vibrato is applied). In an FM radio broadcast, a "carrier"--an extremely high-frequency radio signal which can be transmitted via the atmosphere--is used to "carry" the program material. The program material "modulates" the radio-frequency carrier.

In the FM tone generator, the carrier and modulator function as follows:

CARRIER: determines the level and pitch of the sound.

MODULATOR: determines the timbre of the sound.

Of course, the carrier and modulator frequencies are much closer together in the FM tone generator than they are in an FM broadcast, and they are both pure sine waves.

The 2 Main Merits of FM

In an FM broadcast, since the carrier frequency is somewhere around 80 million hertz (cycles) and the music signal which modulates it contains frequencies which are much lower--20 Hz to 20,000 Hz, the music signal is basically unchanged by the carrier. If we bring the frequencies of the carrier and modulator much closer together, however, we begin to generate new signal components--harmonics of the modulator and/or carrier and noise components.

It is these modulator-carrier characteristics that we take advantage of in the FM tone generator. Its first big benefit is that the FM generator is capable

Fig. 1. DX1 Digital Synthesizer Design

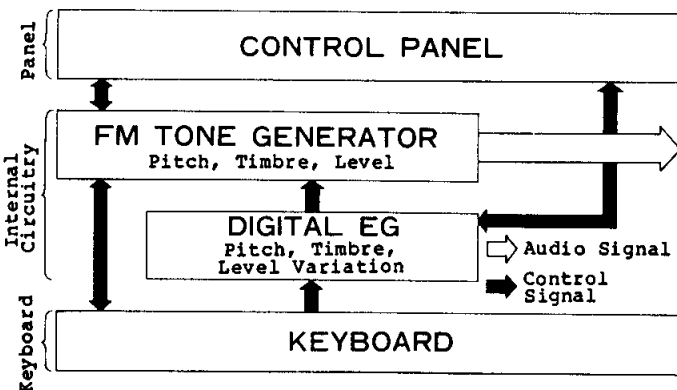

of closely controlling the pitch, timbre and level of the sound produced without the need for conventional VCO (Voltage Controlled Oscillator--pitch control), VCF (Voltage Controlled Filter--Timbre) or VCA (Voltage Controlled Amplifier--level) elements. Further, while the conventional VCF controls timbre by removing certain harmonics from the sound, the FM tone generator works by adding harmonics as required--and where required--for much more sound control versatility. In fact, the harmonic spectrum of a voice can be programmed with total freedom.

Another major benefit of the FM system is that noise components that conventional VCOs are simply incapable of producing can be easily generated. Noise is a very important part of the sound of any acoustic instrument--not just the instrument's pure tonal harmonics. For example, in a violin there is bowing noise, breath noise in a saxophone sound, or the purely percussive portion of a drum sound. The FM tone generator system permits producing total sound such as these, incorporating both purely tonal and noise spectra. Specifically, random harmonic structures and noise can be produced by setting the ratio of modulator and carrier frequencies so one is not a multiple of the other, and by greatly increasing the modulation level. Of course, it is then possible to use the DX1 EG to independently control different portions of the sound.

The FM Tone Generator and Algorithms

The DX1 has two FM tone generator channels--A and B. Each channel has 6 OPERATORS--a total of 12--which are the basic FM voice building blocks. An operator is essentially a sine wave oscillator that can be used either as a modulator or as a carrier. Furthermore, since the DX1 is an all-digital instrument, these sine wave oscillators function by "reading" the sine wave from a digital sine wave memory, rather than by using conventional analog oscillator circuitry, for exceptional precision and stability.

The six operators in each channel can be combined in many ways, with different configurations and modulator-to-carrier relationships. Such operator "patterns" are called ALGORITHMS. The simplest form of algorithm is a combination of two operators--one a carrier and one a

modulator. This combination is shown in fig. 2 below.

Fig. 2. FM Sound Source Basic Algorithm

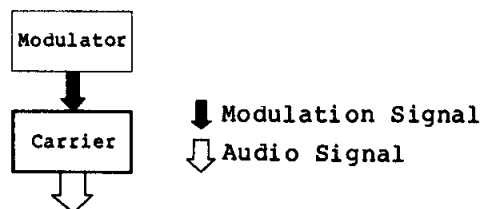

Without any modulation, an operator produces a pure sine wave with absolutely no harmonic content other than the fundamental frequency. When modulation is applied, however, a rather complex waveform with a complex harmonic structure is produced (fig. 3). There are three main ways of controlling the resultant waveform. They are:

- The frequency ratio between modulator and carrier.
- Modulator output level.
- Feedback.

The DX1 uses all three of these control elements to create an unbelievably broad spectrum of natural voices.

Fig. 3. FM Waveform Variation

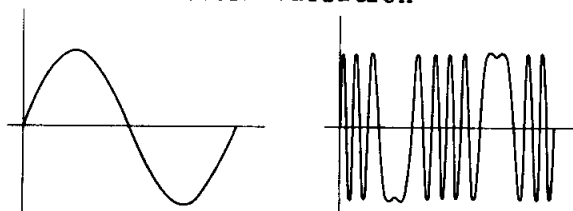

Waveform before modulation by carrier. (Sine Wave) Waveform after modulation by carrier. (Complex wave)

The actual algorithms used in the DX1 are a little more complex than the one shown above. Carriers may be arranged "side by side" as shown in fig. 4, or many modulators may be piled on top of one another to create a "chain" of modulation. Figures 5--7 are examples of actual DX1 algorithms. 32 different algorithm patterns are provided, and can be used independently in channels A and B. The two channels can then be mixed in any way desired to create a range of voices unprecedented in any electronic music synthesizer system.

Fig. 4. Parallel Carrier Algorithm

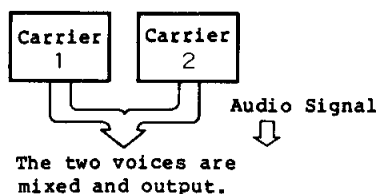

Fig. 5. DX1 Algorithm 1

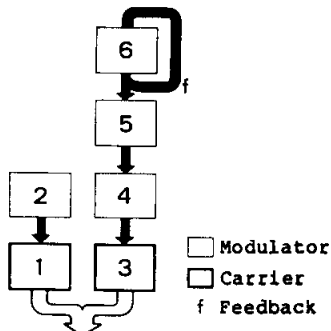

Fig. 6. DX1 Algorithm 18

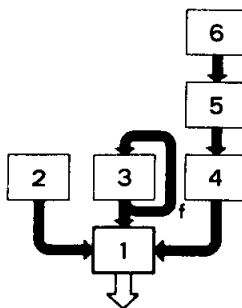
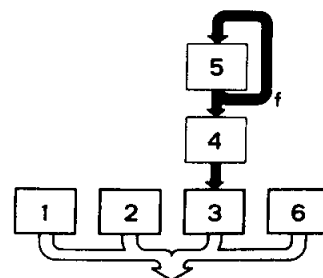

Fig. 7. DX1 Algorithm 30



DX1 FEATURES AND FUNCTIONS

Despite of the fact that the DX1 has a vast number of functions, its control panel is remarkably simple. This has been made possible by the use of many multi-function switches that change their function according to the number of times they are pressed. This system of providing many functions with the smallest number of switches is similar to that of using an alphanumeric keyboard for inputting commands on a large computer. In this section we will briefly introduce the features and functions of the DX1 control panel.

2-1 The 4 modes of the DX1

The DX1 has four main modes. These are selected using the MODE selectors. Each mode has its own set of parameters.

PLAY MODE

In this mode, voice and effect data called can be used directly in performance. Although there is no specific switch for this mode, it is the basic mode selected when the three modes described below are all turned OFF. In the play mode, the PERFORMANCE MEMORY/FUNCTION and VOICE MEMORY buttons become the play mode voice selectors.

EDIT MODE

In this mode voice data can be programmed. Data already contained in the voice memory can be edited and changed, or completely new voices can be created simply by inputting the appropriate data. The edit mode takes priority over the play mode.

FUNCTION MODE

In this mode the many effects used during performance can be set. Commands related to memory control and the MIDI terminal are also included in this mode. This mode takes priority over both the play and edit modes.

STORE MODE

In this mode data can be stored in the voice and performance memories. Voice parameters in the EDIT mode can be memorized in the VOICE MEMORY, and function parameters and VOICE MEMORY numbers can be combined and recorded in the PERFORMANCE MEMORY. The store mode takes priority over the play, edit and function modes.

2-2 Control Panel (fig. 8)

The DX-1 control panel has the following

Fig. 8. DX1 Control Panel

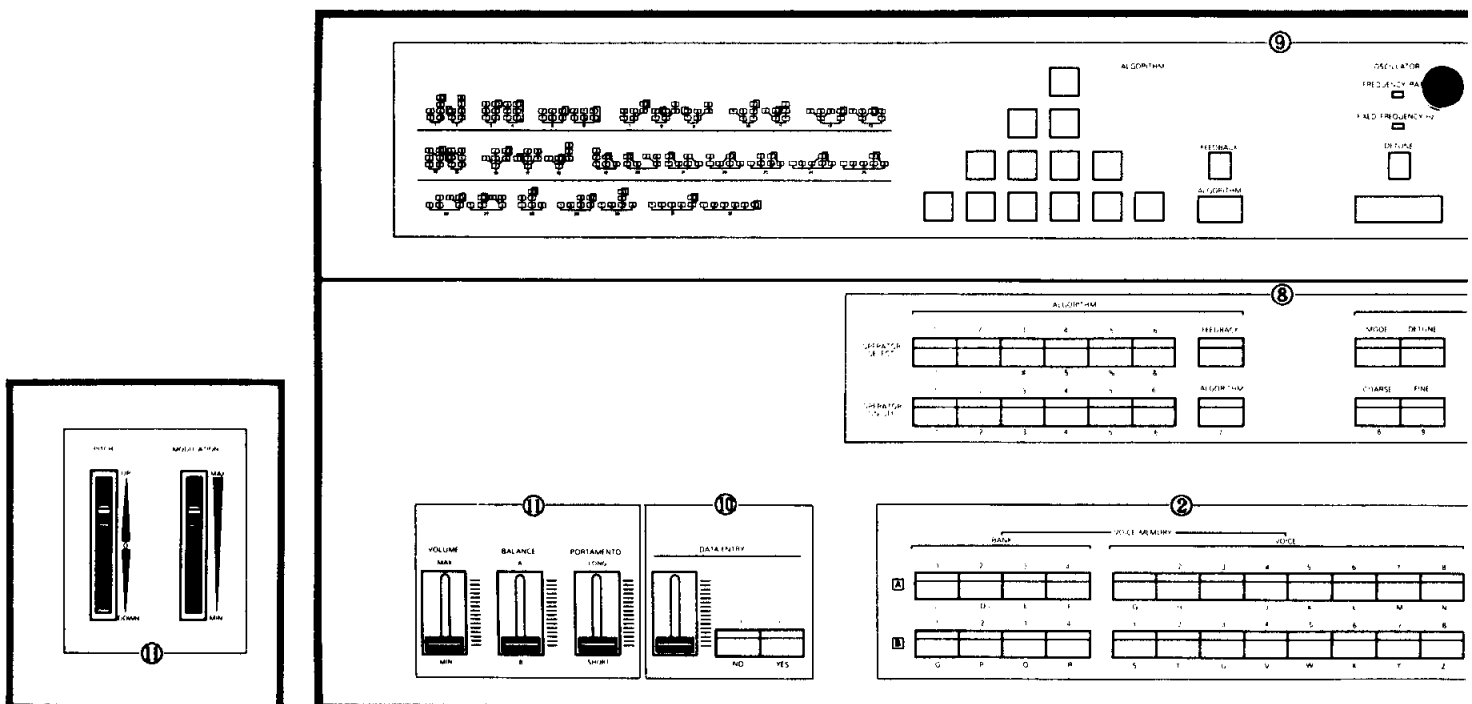

control/function groups:

1. MODE SELECTOR
2. VOICE MEMORY
3. CARTRIDGE SW
4. CARTRIDGE SLOT
5. PERFORMANCE MEMORY/FUNCTION
6. KEY ASSIGN MODE SW
7. LCD DISPLAY
8. VOICE PARAMETER SW
9. LED DISPLAY
10. DATA ENTRY
11. WHEEL CONTROLLER/SLIDER

(1) MODE SELECTORS These selectors are used to call the desired mode. When a mode selector is pressed its indicator lights.

- * If more than one mode selector is pressed at one time, the indicators of all the pressed buttons will light. However, more than one mode cannot be selected at the same time.
- * The priority of the modes is given below.

(1 STORE/2 FUNCTION/3 EDIT/4 PLAY)

EDIT/COMPARE

This button calls the edit mode. The compare function incorporated in this selector permits comparison of the sound of a voice being edited with that of the original voice. -P.21

- * The voice parameter switches arranged beneath the LED display and the PERFORMANCE MEMORY/FUNCTION switches are used to select the voice parameters to be edited, and data is entered using the DATA ENTRY section.
- * The VOICE and PERFORMANCE MEMORY selectors are locked during the edit mode, and cannot be changed.

FUNCTION

This calls the function mode.

- * The function is determined using the PERFORMANCE MEMORY/FUNCTION switches then data is entered using the DATA ENTRY section.
- * If the EDIT/COMPARE switch is either off or flashing during the function mode, different voice memory buttons can be selected.
- * Since the performance memory and function mode buttons are integrated, the performance memory cannot be changed while in the function mode.

STORE

This is the mode which permits storage of data in the various memory locations. -P.52

- * The VOICE MEMORY and/or PERFORMANCE MEMORY/FUNCTION positions are selected and operation is performed via the DATA ENTRY section.
- * The FUNCTION switch, EDIT switch, and VOICE MEMORY and PERFORMANCE MEMORY are locked during the store mode, and will not function until the store mode is disengaged.

(2) VOICE MEMORY

These are the VOICE MEMORY position selectors. Two channels are provided, one each for tone generators A and B, Each channel has 32 memory positions. The bank selectors determine which voice bank is selected, and the voice switches determined which voice within that bank is selected.

- * When the CARTRIDGE switch is ON the selectors select the cartridge memory. Positions cannot be re-selected in the edit or store modes. -P.13

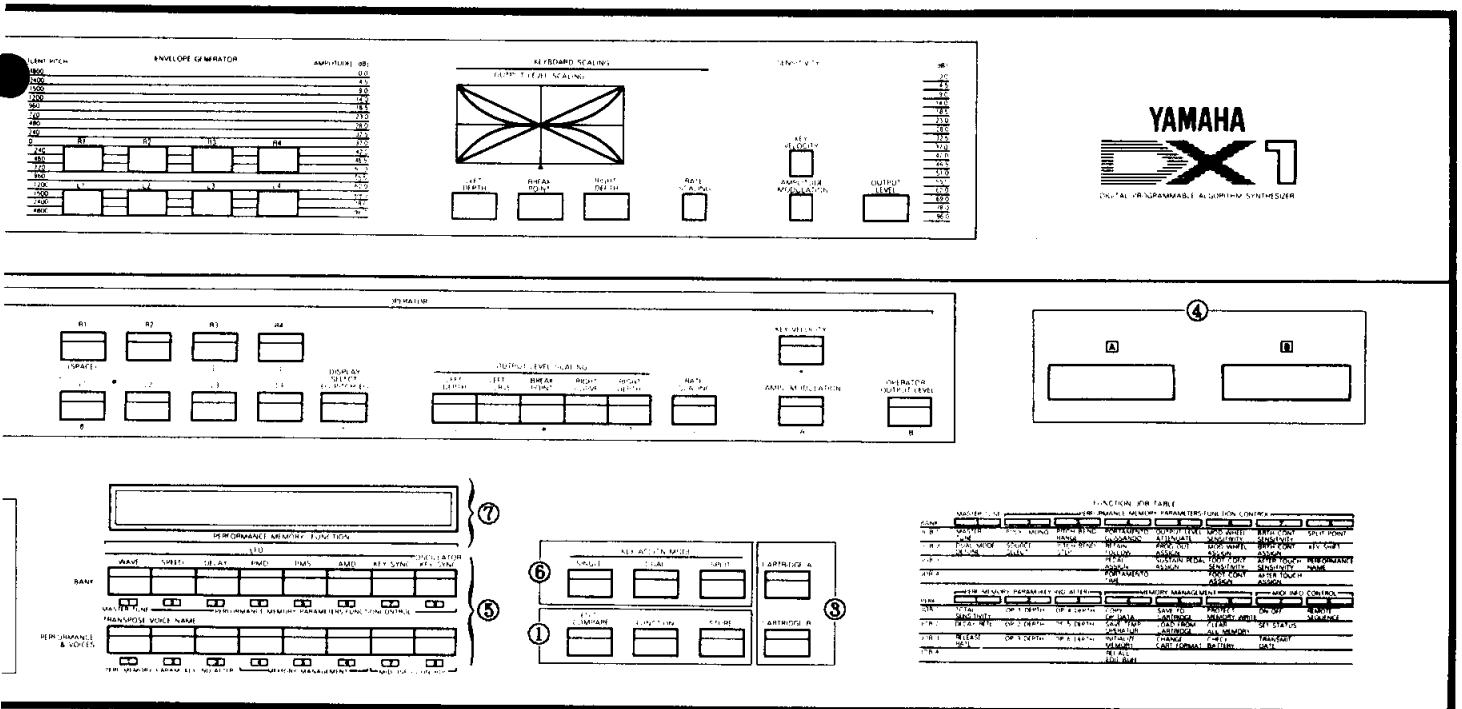

(3) CARTRIDGE SWITCHES

These switches select cartridge voices. When pressed the VOICE MEMORY selectors select the corresponding voices within the cartridge.

(4) CARTRIDGE SLOTS

Cartridges are inserted here. ROM cartridges and RAM cartridges are both inserted into the same slots.

- * When VOICE ROM CARTRIDGES are inserted, cartridge A and B voices go to the corresponding voice memory channels A and B.
- * PERFORMANCE ROM CARTRIDGES should be plugged into the A slot.
- * Two DX1 VOICE ROM CARTRIDGES, Two DX7 VOICE ROM CARTRIDGES and one PERFORMANCE MEMORY CARTRIDGE are provided with the DX1.
- * VOICE ROM CARTRIDGES incorporate 2 banks of voices which can be selected with a switch in the cartridge. Select the required bank before inserting the cartridge in the slot.
- * The DX1 VOICE ROM CARTRIDGES have the same voices as the main unit on side I, and side II contains completely different data. The DX7 VOICE ROM CARTRIDGES contain data not contained in the DX1 internal memory on both banks.
- * RAM CARTRIDGE features a memory protect switch which prevents accidental erasure of the data in the RAM CARTRIDGE. Be sure to turn memory protect off before attempting to write to a RAM CARTRIDGE.

(5) PERFORMANCE MEMORY/FUNCTION

- * In the PLAY mode, these are the PERFORMANCE MEMORY position selectors which select a memorized voice number and effect combination. 64 PERFORMANCE MEMORY positions are provided. The upper row selects the bank and the lower row selects the memory position. The performance name and voice name are displayed on the LCD display. →P.12
- * In the FUNCTION mode these are the function parameter selectors. The parameter name and data are displayed on the LCD display. →P.33
- * In the EDIT mode the upper row 1--8 buttons and lower row 1 and 2 buttons become the edit parameter selectors. The parameter names and data are displayed on the LCD display in this case also. →P.27
- * In the STORE mode these selectors select the performance memory to which the store operation is targeted. →P.52

(6) KEY ASSIGN MODE BUTTONS

These select which tone generator channel will be playable via the keyboard. →P.42

SINGLE

Only the A or B channel may be selected at a

time. In the polyphonic mode the maximum number of notes that can be played simultaneously is 32. In this case outputs A and B both output a monaural signal corresponding to the channel in use.

DUAL

Both channels A and B can be used simultaneously. In the polyphonic mode the maximum number of notes that can be played simultaneously is 16.

SPLIT

This permits splitting the keyboard at any point and having channels A and B applied to the keyboard sections above and below the set split point. In the polyphonic mode the maximum number of output notes is 16 for each channel.

(7) LCD (Liquid Crystal Display)

- ** In the PLAY mode this display displays the voice name and its memory position (number), or the performance memory name and its memory position.
- ** In the EDIT mode the parameter name and data are displayed.
- ** In the FUNCTION mode the parameter name, the control prompts and data are displayed.
- ** In the STORE mode the memory position and control prompts are displayed.

(8) VOICE PARAMETER SWITCHES

When the EDIT mode is called voice data is displayed on the LCD display and these switches permit editing of the data.

- * Pressing a voice parameter switch selects the corresponding parameter, and data is entered using the DATA ENTRY section.
- * Data can also be changed by continuously pressing a voice parameter switch. The data value increases in 1-step increases, and when the maximum value is exceeded the display begins from the lowest value again.

(9) LED DISPLAY

This graphically displays parameter data in the EDIT mode. A bar-graph type display shows level information.

- * In the EDIT mode, parameters and data being worked on are shown by flashing sections on the display.

(10) DATA ENTRY

In the EDIT, FUNCTION and STORE modes, data entry is performed at this section.

- * Data can be input either by using the slider control or +/- button. The slider control permits broad-range data variation, while the +/- button permits fine data control in 1-step increments. The +/- switch also functions to turn certain parameters ON or OFF.
- * It also serves to answer YES or NO to

control prompts which appear on the LCD display.

(11) WHEEL CONTROLLER/SLIDER

VOLUME

This is the DX1 master volume control

BALANCE

This adjusts the volume balance between channels A and B.

PORTAMENTO

This adjusts the portamento time.

- * When the FUNCTION mode PORTAMENTO PEDAL & KNOB ASSIGN is OFF, portamento will not function. →P.36

PITCH

This is the pitch bend wheel.

- * This will not function when the FUNCTION mode PITCH BEND RANGE parameter is set to 0. →P.36

MODULATION

This controls LFO modulation. That is, the depth of vibrato, tremolo and wow effects.

- * When the FUNCTION mode MOD WHEEL ASSIGN is set to EBC (EG BIAS CONTROL) this functions as a volume or brilliance control. →P.38
- * Modulation will not function when the EDIT mode AMPLITUDE MODULATION SENS. parameter is set to 0, and the PITCH MODULATION SENS. parameter is set to 0. →P.27
- * This will not function when the FUNCTION mode MOD WHEEL SENSITIVITY parameter is set to 0 or when the MOD WHEEL ASSIGNS are all OFF. →P.38

2-3 Connection Terminals

The following types of connection terminals are provided:

1. AUDIO OUTPUT
2. CONTROL CONNECTOR
3. MIDI CONNECTOR

Please connect the power cord, amplifier, peripheral equipment and accessories correctly, as shown in the illustration. The connector terminals are provided in two locations: on the rear panel (fig. 9a), and to the lower left of the keyboard (fig. 9b).

(1) AUDIO OUTPUT

OUTPUT (fig. 25a)

Audio outputs A, B and P are provided. Both unbalanced phone jack and balanced XLR type connectors are provided for each output, for a total of 6 audio output connectors.

A

This is the output for tone generator

output channel A (memory A). However, when the KEY ASSIGN MODE is set to single, either channel A or B, whichever is in use, will be simultaneously output from this jack.

B

This is the output for tone generator output channel B (memory B). However, when the KEY ASSIGN MODE is set to single, either channel A or B, whichever is in use, will be simultaneously output from this jack.

P (PROGRAM)

This output provides a monaural mix of channels A and B. It is normally ON. The FUNCTION mode PROGRAM OUTPUT ASSIGN function can be used to independently turn channels A and B on or off as required for this output. →P.37

- * The unbalanced phone jack outputs are for connection to reproduction equipment with unbalanced type inputs. In order to appreciate the extremely broad dynamic range of the DX1 we recommend the use of a high-performance keyboard amplifier or integrated PA amplifier/speaker system.
- * The balanced XLR type connectors are intended mainly for use in professional applications where noise must be kept to an absolute minimum. These terminals should be used in sound reinforcement and recording situations.
- * The output level at outputs A, B and P is controlled by the FUNCTION mode OUTPUT LEVEL ATTENUATE parameter. If the OUTPUT LEVEL ATTENUATE parameter is set to 0, no sound will be output.

PHONES (fig. 9b)

This jack accepts virtually any standard pair of headphones. It outputs a mono mix of the channel A and B signals.

PHONE VOLUME (fig. 9b)

This controls the level of the headphones. The PHONES volume control controls headphone volume independently from the main volume slider control.

(2) CONTROL CONNECTORS

VOLUME (fig. 9a)

This connector permits foot control of volume level. An FC-3A foot controller can be connected here.

- * In this case the volume slider control should be set to its maximum setting.

MODULATION (fig. 9a)

This connector permits foot control of the depth of LFO modulation (vibrato, tremolo, wow) and EG bias (volume, brilliance). An FC-3A foot controller can be connected here.

- * The foot controller will not function

if the EDIT mode AMPL. MODULATION and PITCH MODULATION SENS. parameters are set to 0. →P.27

- * The foot controller will not function if the FUNCTION mode FOOT CONT SENSITIVITY parameter is set to 0 and the FOOT CONT ASSIGNS are all OFF. →P.38

SUSTAIN (fig. 9a)

This permits ON/OFF control of the sustain function by connecting an FC-4 or FC-5 footswitch.

- * The footswitch will not function if the FUNCTION mode SUSTAIN PEDAL ASSIGN is off. →P.37

PORTAMENTO (fig. 9a)

This connector permits connection of an FC-4 or FC-5 footswitch to turn the portamento effect ON or OFF.

- * The footswitch will not function if the FUNCTION mode PORTAMENTO TIME parameter is set to 0, or the PEDAL ASSIGN parameter is turned OFF. →P.37

BREATH CONTROLLER (fig. 9b)

A BC-1 breath controller can be connected here for breath control of LFO modulation or EG bias.

- * The breath controller will not function if the EDIT mode AMPLITUDE MODULATION and PITCH MODULATION SENS. parameters are set to 0. →P.27
- * The breath controller will not function

if the FUNCTION mode BRTH CONT. SENSITIVITY parameter is set to 0 and the BRTH CONT. ASSIGNS are all OFF. →P.39

(3) MIDI CONNECTOR (fig. 9a)

MIDI stands for Musical Instrument Digital Interface. This interface permits transmission and reception of digital data for control purposes. The MIDI terminal can be connected to the YAMAHA KX1 REMOTE KEYBOARD, any other keyboard with a MIDI terminal, or a personal computer system. A MIDI cable must be used. →P.61/P.72

IN

This is an input terminal which receives data from another instrument or computer. The KX1 REMOTE KEYBOARD is also connected here.

OUT

This is the output for the DX1 digital control signals. The DX1 can be used to control other instruments, or DX1 voice or performance data can be read into an external computer.

THRU

This outputs the same data as received at the IN terminals, permitting chaining of more than two instruments, computers, sequencers or other MIDI equipment.

Fig. 9. Connection Terminals

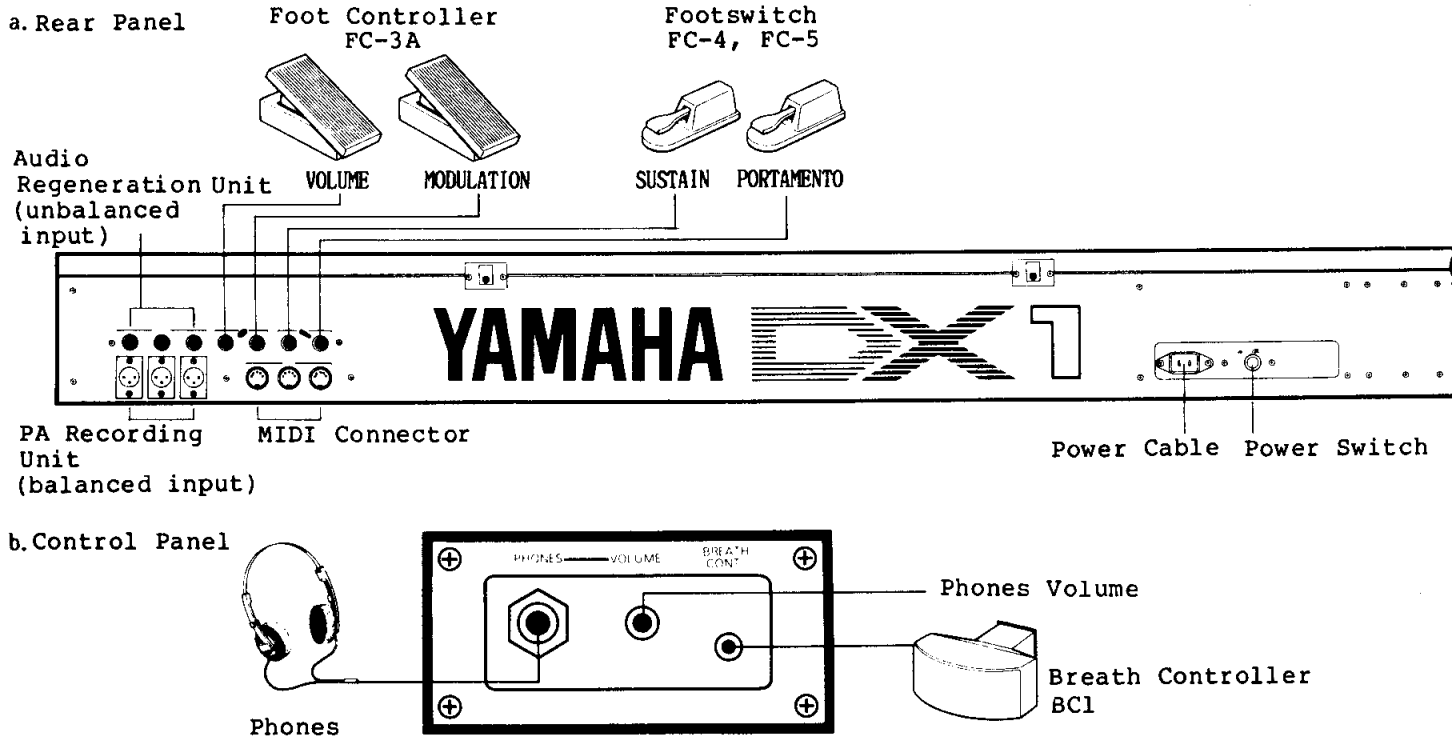

PLAY mode/PERFORMANCE MEMORY

In the PLAY mode, data already in the memory is used for performance. In this section we'll describe how to call out the required voice for performance, and how memory positions can be changed without altering the voice or performance data.

3-1 PERFORMANCE MEMORY & VOICE MEMORY

What is PERFORMANCE MEMORY?

In the DX1 the two channels of internal VOICE MEMORY or external cartridge VOICE MEMORY are combined with the FUNCTION mode effects to form the complete performance voices. The PERFORMANCE MEMORY is a memory in which the VOICE MEMORY numbers are combined with effects and stored. Channel A/B combinations and the addition of effects can be freely set up and stored in the PERFORMANCE MEMORY. In the PLAY mode complete voices can be easily selected using the PERFORMANCE MEMORY switches. →P.12

- * When the DX1 is initially shipped, its PERFORMANCE MEMORY contains 64 combinations pre-programmed at the Yamaha factory, permitting immediate performance when the instrument is received. The PERFORMANCE MEMORY banks 1--4 hold the internal voice memory, and banks 5--8 select the DX1 VOICE ROM cartridge side II memory.
- * Voice and effect combinations are stored in the PERFORMANCE MEMORY as a number. The actual voice data (the EDIT mode parameters) are not memorized.
- * The internal RAM (Random Access Memory) VOICE MEMORY can be used to store all EDIT mode parameters. When the instrument is initially shipped, the VOICE MEMORY contains 32 voices in each channel, A and B, for a total of 64 voices.
- * The 5 ROM (Read Only Memory) cartridges provided contain original Yamaha voices and effect data.
- * The two DX1 VOICE ROM CARTRIDGES each contain 64 voices for a total of 128 voices. Each cartridge has two sides: I and II. The I/II switch is used to select the desired side. Side I contains the same voices as are initially stored in the instrument's internal memory, and side II contains different voices. Be sure to switch to the desired side before plugging a cartridge into the DX1. →P.13
- * The two DX7 VOICE ROM CARTRIDGES provided also contain 64 voices each for a total of 128 voices.
- * The PERFORMANCE ROM CARTRIDGE contains the same 64 effect "settings" as the

DX1 internal PERFORMANCE MEMORY. When this cartridge is inserted into the DX1, the data it contains is called into the internal memory, combined with the desired voice data and used for performance.

- * Up to 32 original voices (voice parameters) or 64 original effects (function parameters) can be stored in the RAM cartridges. When a RAM cartridge is plugged into the DX1, original data can be freely called from it.
- * The RAM cartridges are initially shipped set up with the VOICE MEMORY (voice parameter) format. To use the RAM cartridge for PERFORMANCE MEMORY storage (function parameters), use the FUNCTION mode CHANGE CART. FORMAT →P.46 function.

The BUFFER

- * The buffer is a special separate memory into which DX1 data is called from memory for performance or editing. A buffer is provided for the PERFORMANCE MEMORY and the VOICE MEMORY. When a memory number is selected, the data corresponding to that memory number is read into the buffer (fig. 10).
- * In the PLAY mode data read into the VOICE EDIT BUFFER and PERFORMANCE EDIT BUFFER is used as is for performance.
- * In the EDIT mode VOICE MEMORY data is read into the VOICE EDIT BUFFER for editing.

Fig.10. Buffer Circuitry

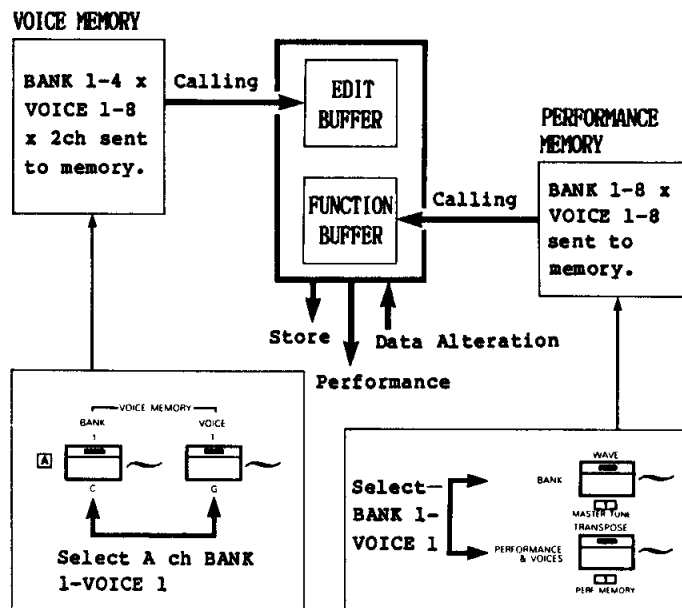

- * In the FUNCTION mode PERFORMANCE MEMORY effect data is read into the PERFORMANCE EDIT BUFFER for editing.
- * In the STORE mode, data in the VOICE EDIT BUFFER or PERFORMANCE EDIT BUFFER is stored or copied into the VOICE MEMORY or PERFORMANCE MEMORY.
- * In the DX1 the memory backup system also provides backup power to the buffer data. When the DX1 power is turned OFF, the basic data which was being used at the time is held in memory, and is available immediately power is turned back on.

3-2 Calling Memory Data

(1) Calling the DX1 PERFORMANCE MEMORY (fig. 11)

With the PERFORMANCE MEMORY it is possible to call out voice data and effect data simultaneously. At the same time the effect data is called into the PERFORMANCE EDIT BUFFER, the selected voice number data is called into the VOICE EDIT BUFFER.

- Turn all MODE selectors (EDIT, FUNCTION, STORE) OFF.
 - Insert two VOICE MEMORY CARTRIDGES into the DX1.
 - Using the upper row of 8 bank selectors in the PERFORMANCE MEMORY/FUNCTION section, select the desired bank number, and select the desired voice + effect with the lower row of 8 buttons. In this way a total sound, incorporating the voice data and effects, is called.
- * As shipped, banks 1--4 contain the internal DX1 VOICE MEMORY, and banks 5--8 contain the cartridge voice data.
- The LCD display displays the performance name as "PERFORMANCE MEMORY #1-1 **XXXX**", or the voice name as "INT A1-1 YYYY POLY SRC=0 INT B1-1 ZZZZ POLY SRC=0".
 - The "#1-1" in the performance name display is the memory number, and XXXX is the performance name (fig. 12).
 - In the voice name display the upper and lower rows display the channel A and B voice names, respectively. "INT A1-1" and "INT B1-1" are the memory numbers, while "YYYY" and "ZZZZ" are the voice names. The data following "POLY" are

- function parameters that need to be checked for performance (fig. 13). → P.35
- * The voice name and performance name display can be switched by pressing the bank selectors.
- * When the KEY ASSIGN MODE is set to SINGLE, the voice name displayed is either that of channel A or B depending on which is in use.
- * If a PERFORMANCE MEMORY CARTRIDGE (i.e. a cartridge formatted for PERFORMANCE MEMORY) is inserted in the DX1, selecting banks 5--8 results in a momentary "***ERROR** Cartridge format conflict!" message, and the voice data will be called from the internal VOICE MEMORY, banks 1--4. In this case go back to step (b) above and repeat the process correctly.

Fig. 12. Method of Indicating Performance Name

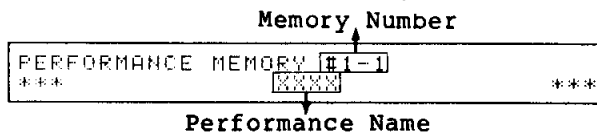
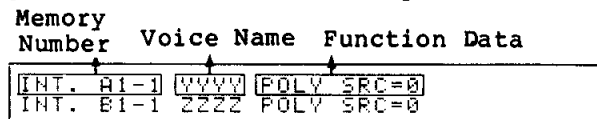

Fig. 13. Method of Indicating Voice Name



(2) Calling the internal VOICE MEMORY (fig. 14)

In the PLAY mode it is possible to use the DX1 VOICE MEMORY switches to directly call VOICE MEMORY data into the VOICE EDIT BUFFER without calling a PERFORMANCE MEMORY (in which the voice number is combined with effect data) and add effects as required while playing.

- Turn all MODE selectors OFF.
 - Use the bank select switches in the VOICE MEMORY switch group to select the desired banks for channels A and B.
- * If the KEY ASSIGN MODE is set to SINGLE then only channel A or channel B, whichever is in use, needs to be set.
- Then, using the VOICE MEMORY voice switches, select the desired voice number. This causes the selected VOICE MEMORY data to be called into the VOICE EDIT BUFFER.

Fig. 11. Calling Internal Performance Memory

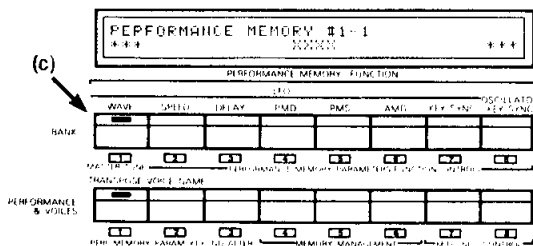

(d) Displays change in voice and performance names when lighted bank switch is pressed.



(a) Mode selectors (edit, function, store) all off.

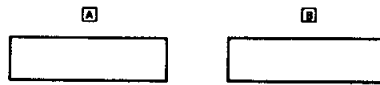

(b) Place cartridges in cartridge slot.

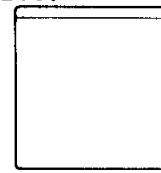

Select side cartridge or to be used (when using ROM cartridge).

(c) Select desired bank, performance, and voice switch.

- * The selected PERFORMANCE MEMORY data will be effective with the voice data called until the FUNCTION mode is used to reset the performance memory data.
- (d) The voice name display consists of the name of the voice called. The "INT" portion of the display indicates that the internal memory is selected.
- * The performance name will not change even if the VOICE MEMORY buttons are pressed.

(3) Calling a cartridge VOICE MEMORY

It is also possible to use the DX1 VOICE MEMORY switches to directly call VOICE MEMORY CARTRIDGE data into the VOICE EDIT BUFFER for performance. In particular this process is suited for calling voice data from the DX7 VOICE ROM CARTRIDGES.

- (a) Turn all MODE selectors OFF.
- (b) In the case of a ROM cartridge set the cartridge bank selector switch before inserting the cartridge.
- (c) Insert the cartridge into the cartridge slot.
- (d) Press the CARTRIDGE switch to initialize the cartridge access mode.
- * If the CARTRIDGE switch is pressed without inserting a cartridge the LCD display will show "***ERROR** Cartridge not ready!". In this case go back to step (c) and properly insert the cartridge.
- * If a PERFORMANCE MEMORY CARTRIDGE (a cartridge formatted for PERFORMANCE MEMORY) is inserted, the "***ERROR** Cartridge format conflict!" message will be displayed. In this case the data originally in the buffer will not

- be affected. Go back to step (c) and insert the correct cartridge.
- (e) Using the VOICE MEMORY BANK switches select the desired bank.
- * If the KEY ASSIGN MODE switch is set to SINGLE, then only channel A or B, whichever is in use, needs to be set.
- (f) Using the VOICE MEMORY voice switches select the desired voice number. This causes the selected cartridge voice number to be called into the VOICE EDIT BUFFER ready for performance.
- * The effects are set up according to the currently selected PERFORMANCE MEMORY unless the FUNCTION mode is used to reset the PERFORMANCE MEMORY parameters.
- (g) The voice name display displays the name of the voice called from the cartridge.
- * The "EXT" portion of the display indicates that the external cartridge memory is being used.

(4) Calling a cartridge PERFORMANCE MEMORY (fig. 16)

It is possible to call PERFORMANCE MEMORY CARTRIDGE data into the PERFORMANCE EDIT BUFFER and call internal VOICE MEMORY data into the VOICE EDIT BUFFER, combining the two for performance.

- * The method for calling data from the PERFORMANCE MEMORY CARTRIDGE is different from that for calling data from a VOICE MEMORY CARTRIDGE, so care should be taken to follow the correct procedure.
- (a) Turn all MODE selectors (EDIT, FUNCTION, STORE) OFF.

Fig. 14. Calling Main Unit Voice Memory

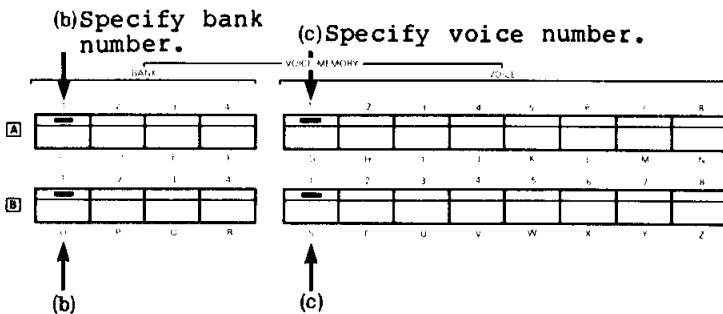

(d) Displays change in voice and performance names when lighted bank switch is pressed.

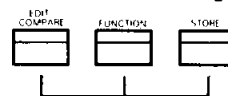

(a) Mode selectors all off.

Fig. 15. Calling Cartridge Voice Memory

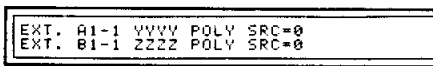
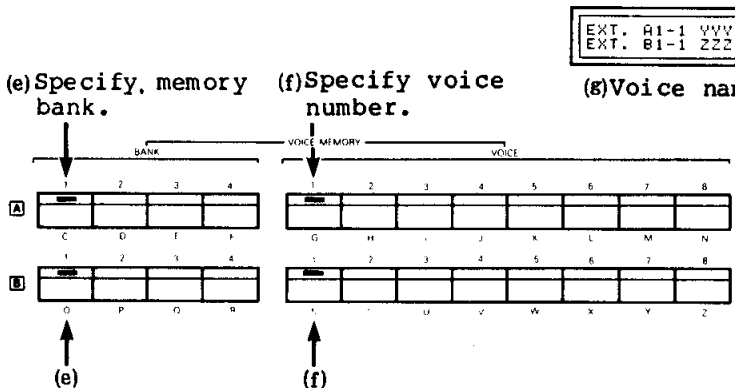

(g) Voice name display.

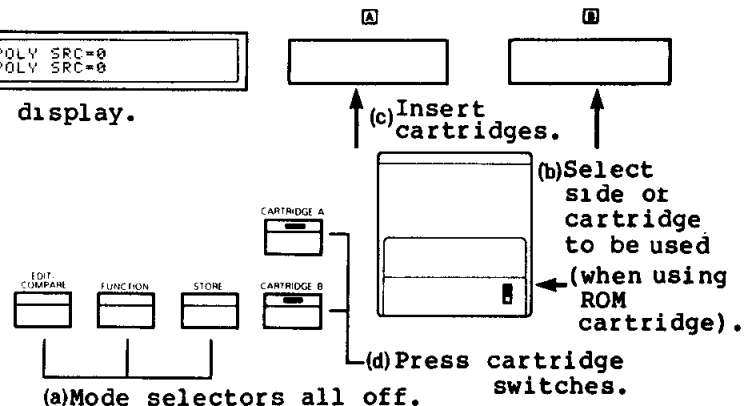

- (b) Insert the PERFORMANCE MEMORY CARTRIDGE into cartridge slot A.
- * The cartridge B slot cannot be used.
- * If the PERFORMANCE MEMORY CARTRIDGE is inserted into the B slot, the **"**ERROR** Cartridge not ready!"** message will be displayed, when the following operations are performed.
- (c) Press CARTRIDGE switch A while holding down any one of the PERFORMANCE MEMORY/FUNCTION section buttons. This initiates access to the PERFORMANCE MEMORY CARTRIDGE.
- * When the PERFORMANCE MEMORY CARTRIDGE has been accessed, the last section of the upper row of the performance name display will read "**<<CARTRIDGE>>**".
- * If a PERFORMANCE MEMORY switch is not held, or it is released before the CARTRIDGE button is pressed, or a VOICE MEMORY CARTRIDGE is inserted instead of a PERFORMANCE MEMORY CARTRIDGE, the **"**ERROR** Cartridge format conflict!"** message will be displayed, and the desired data will not be read.
- (d) Then by using the PERFORMANCE MEMORY bank and PERFORMANCE & VOICE switches, the desired effect data can be called into the PERFORMANCE EDIT BUFFER.
- * Only cartridge data which is called into the PERFORMANCE EDIT BUFFER can be used. Once the cartridge is removed from the cartridge slot, all other PERFORMANCE MEMORY positions other than the one that was called into the PERFORMANCE EDIT BUFFER can no longer be used. Further, if the CARTRIDGE switch is turned OFF then the internal PERFORMANCE MEMORY will be called into the PERFORMANCE EDIT BUFFER and the cartridge data will be lost.
- * If the effect data in the PERFORMANCE EDIT BUFFER needs to be saved, use the store performance function. →P.53
- * In order to use all the PERFORMANCE MEMORY CARTRIDGE data in the internal memory, use the load function. →P.46
- * Since the PERFORMANCE ROM CARTRIDGE supplied with the unit contains the same data as the internal PERFORMANCE MEMORY at the time of shipping, only banks 1--4 can be used. VOICE MEMORY CARTRIDGE data is set for banks 5--8, however, since a VOICE MEMORY

CARTRIDGE cannot be inserted, the internal VOICE MEMORY data is automatically used.

- (e) The performance name and voice name are displayed on the LCD display each time the bank switches are pressed. The performance name display is **"PERFORMANCE MEMORY #1-1 <<CARTRIDGE>> **XXXX**"**.
- * When the supplied PERFORMANCE MEMORY ROM cartridge is used and one of the banks 5--8 is selected, **"Cartridge format conflict!"** will be displayed momentarily before the performance name. As for the voice name, the lower display row will read **"**ERROR** Cartridge not ready!"**. This indicates that banks 5--8 are set up to use the VOICE MEMORY CARTRIDGE data.
- * When it is necessary to change the internal VOICE MEMORY data use the VOICE MEMORY and bank switches to select the desired voice data.
- * Internal PERFORMANCE MEMORY data cannot be called during PERFORMANCE MEMORY CARTRIDGE access. The cartridge switch must be turned OFF in order to call the internal PERFORMANCE MEMORY.
- * If the PERFORMANCE MEMORY CARTRIDGE is removed while it is being accessed, and the internal PERFORMANCE MEMORY is selected, an error will result and data may be lost.

3-3 STORE/MOVING MEMORY

The DX1 permits changing the positions of the PERFORMANCE MEMORY and VOICE MEMORY. The combined preset voices in channels A and B can be selected and re-stored in the PERFORMANCE MEMORY as required.

- * The memory protect function is automatically turned on when the DX1 power is turned on in order to prevent accidental erasure of the internal memory. The memory protect function must be turned OFF in order to change locations of either the PERFORMANCE or VOICE MEMORY.
- * When PERFORMANCE or VOICE MEMORY is moved to a new position, the data that was originally in that position is erased. The position from which the data has been moved, however, still contains the original data. To

Fig. 16. Calling Cartridge Performance Memory

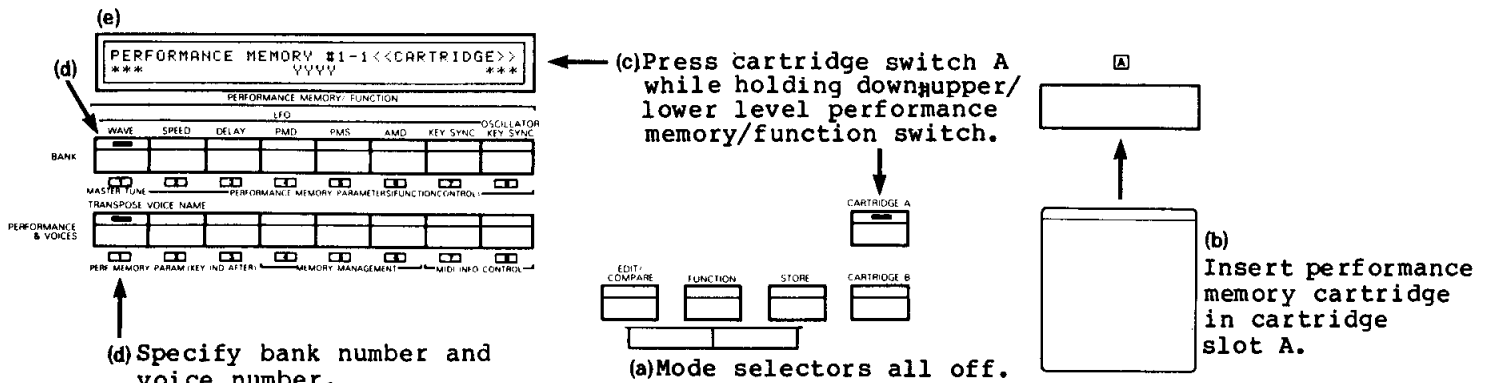

prevent the loss of voice data, be sure to save important voices in an external RAM cartridge. →P.45

(1) Moving Internal PERFORMANCE MEMORY Data (Fig. 17)

- (a) In order to turn OFF the memory protect function, press the FUNCTION switch to enter the FUNCTION mode.
- (b) Press button 6 in the lower row of the PERFORMANCE MEMORY/FUNCTION group, using the memory management function to call the PROTECT MEMORY WRITE function.
- (c) The LCD display will show "Internal memory write protect ON". Press the DATA ENTRY section NO switch, and the display will read "Internal memory write protect OFF", indicating that the write protect function has been turned OFF. Then exit the FUNCTION mode and return to the PLAY mode.
- (d) Select the PERFORMANCE MEMORY position to which you wish to move the data.
- (e) Select the desired A/B channel VOICE MEMORY combination.
- (f) Use the STORE switch to switch to the STORE mode. When this is done, the "STORE ALL FROM >> CURRENT EDITING TO >> CURRENT SELECTED" message will be displayed.
- * The STORE ALL mode permits simultaneous writing to all the internal PERFORMANCE MEMORY and VOICE MEMORY positions. →P.53
- (g) Press the DATA ENTRY section YES switch to begin the store operation. The data combination selected is automatically stored in the PERFORMANCE MEMORY.

* If the memory protect function has not been turned off prior to the above operations, the "***ERROR** W-protected" message will be displayed, and store will not be possible. In this case go back to step (a).

(2) Moving VOICE MEMORY Data (fig. 18)

- (a) Switch to the FUNCTION mode in order to turn off the memory protect function.
- (b) Call the PROTECT MEMORY WRITE function.
- (c) After pressing the DATA ENTRY section NO button, return to the PLAY mode.
- (d) In order to move voices between the internal memory and a cartridge memory, or to change voice positions within a cartridge, make sure the appropriate cartridge is inserted in the cartridge slot.
- * To move voices from the cartridge to the internal memory (single load) press the CARTRIDGE switch.
- * To move voices from the internal memory to a RAM cartridge (single save) make sure the cartridge memory protect switch is OFF, that the cartridge is properly inserted, and that the CARTRIDGE switch is not pressed.
- * To change the position of voices within a RAM cartridge, make sure the cartridge memory protect switch is OFF, the cartridge is properly inserted and the CARTRIDGE switch is pressed.
- * It is not possible to store within a ROM cartridge.
- * A RAM cartridge formatted for VOICE MEMORY (=00) must be used to store

Fig. 17. Shifting and Combining Internal Performance Memory Data

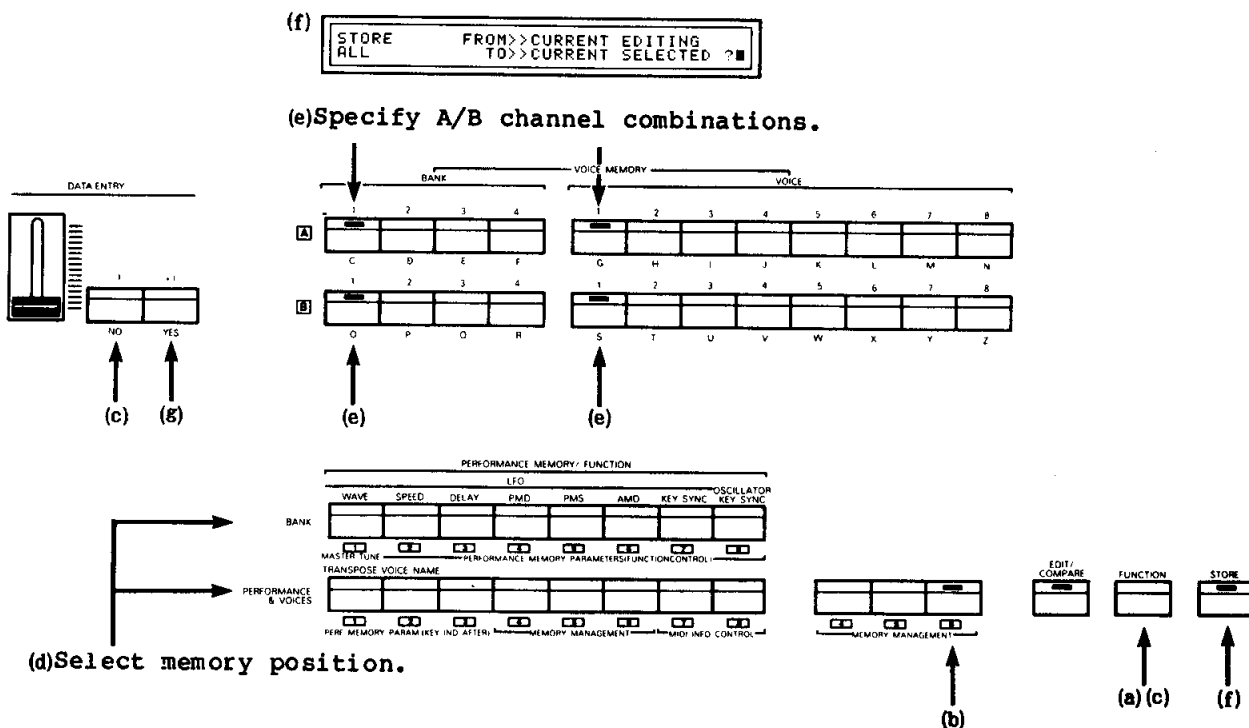

- voice data. A cartridge formatted for performance data (=01) cannot be used.
- (e) Using the VOICE MEMORY switches select the voice that you wish to change the position of.
 - (f) Switch to the STORE mode, and in answer to the LCD display prompt, press the DATA ENTRY section NO button.
 - (g) The display will read "STORE VOICE FROM >> INT A1-1 XXXX TO >> INT A1-1 XXXX", indicating that VOICE MEMORY position change is now possible.
- * The store voice function works only to store VOICE MEMORY data. →P.53
 - * On the display, the "INT A1-1" is VOICE MEMORY position and "XXXX" is the voice name.
 - * Using the STORE VOICE function it is possible to store voices in only one channel at a time. In order to change positions in both channels A and B, go back to step (d) after storing one channel and repeat the procedure for the other channel.
 - (h) After using the VOICE MEMORY bank and voice switches to set the position to which you wish to move a voice, the data following the "TO" portion of the display will show the selected position.
 - * To move data from a cartridge to the internal memory (single load) turn off cartridge access using the CARTRIDGE switch before selecting the position in the internal memory to which the data is to be moved.
 - * To move data from the internal memory to a RAM cartridge (single save) turn on cartridge access using the CARTRIDGE switch before selecting the position in the cartridge to which the data is to be moved.
 - * If a PERFORMANCE MEMORY CARTRIDGE is inserted, the "***ERROR** Cartridge format conflict!" message will be

- displayed after the CARTRIDGE switch is pressed.
- (i) Press the data entry YES key to begin the actual store operation. This completes the voice move process.
- (3) MOVING PERFORMANCE MEMORY (fig. 19)
- (a) Enter the FUNCTION mode in order to turn off the memory protect function.
 - (b) Call the PROTECT MEMORY WRITE function.
 - (c) Press the DATA ENTRY NO key then return to the PLAY mode.
 - (d) To move data between the internal memory and cartridge memory, or within a cartridge, insert the appropriate PERFORMANCE MEMORY CARTRIDGE into cartridge slot A.
- * In order to move data from a cartridge into the internal memory (single load) press CARTRIDGE switch A while holding down the appropriate PERFORMANCE MEMORY/FUNCTION switch. This initiates cartridge access. If the PERFORMANCE MEMORY/FUNCTION switch is not pressed or it is released before the CARTRIDGE switch is pressed, the DX1 expects a VOICE MEMORY CARTRIDGE operation and an error results. In this case the LCD display will read "***ERROR** Cartridge format conflict!".
 - * To move data from the internal memory to an external RAM cartridge (single save) turn the cartridge memory protect switch OFF, insert the cartridge into its slot, and make sure the CARTRIDGE switch is off.
 - * To move data within a RAM cartridge, turn the cartridge memory protect switch OFF, insert the cartridge, then press CARTRIDGE switch A while holding the appropriate PERFORMANCE MEMORY/FUNCTION switch to initiate cartridge access. If the PERFORMANCE

Fig. 18. Moving the Voice Memory

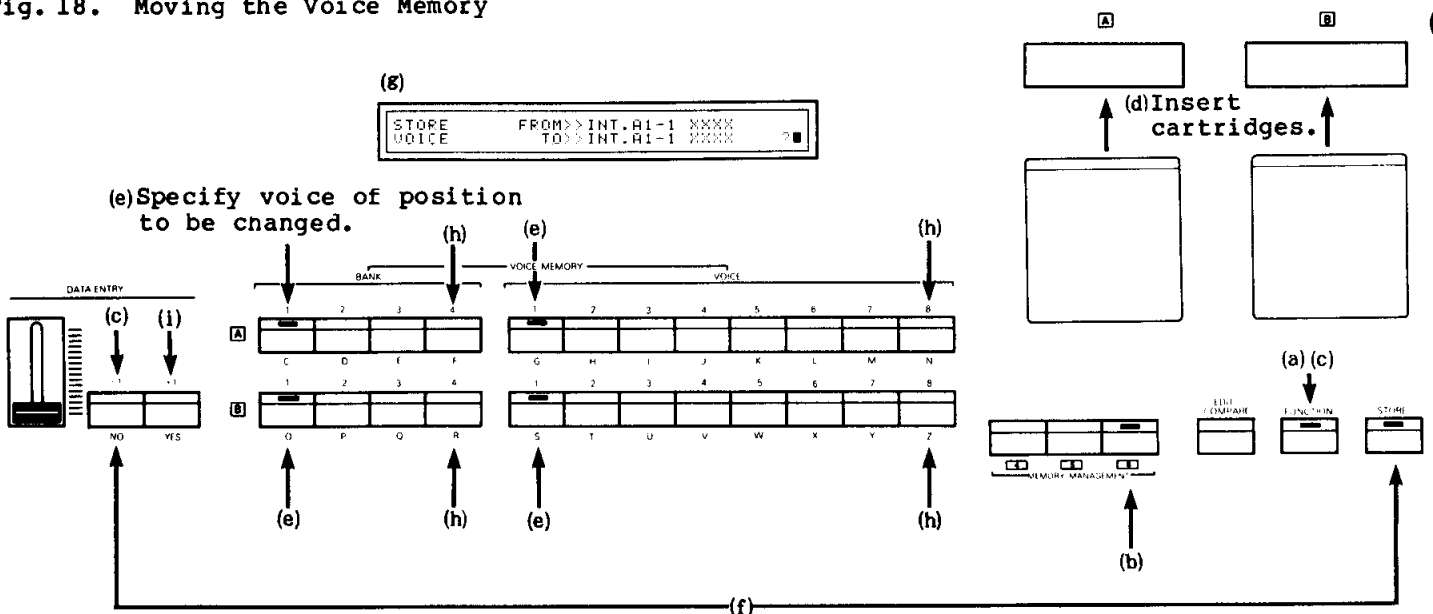

- MEMORY/FUNCTION switch is not pressed, or it is released before the CARTRIDGE switch is pressed, the DX1 expects a VOICE MEMORY CARTRIDGE access operation, resulting in an error. In this case the LCD display will read *****ERROR** Cartridge format conflict!**.
- * If the cartridge is inserted into cartridge slot B, the LCD display will read *****ERROR** Cartridge not ready!**.
 - * The *****ERROR** Cartridge format conflict!** message will also appear if a cartridge which has been formatted for VOICE MEMORY (=00) is inserted instead of one formatted for PERFORMANCE MEMORY.
- (e) Use the PERFORMANCE MEMORY/FUNCTION switches to select the voice you wish to move.
- (f) Switch to the STORE mode.
- (g) Press DATA ENTRY NO button twice.
- (h) The display will now read "STORE PERFORMANCE FROM >> CURRENT XXXX TO >> INT P1-1 XXXX", indicating that it is now possible to change PERFORMANCE MEMORY position.
- * The STORE PERFORMANCE function can only be used to store PERFORMANCE MEMORY data. *-P.53*
 - * The "INT P1-1" portion of the display indicates the PERFORMANCE MEMORY position, and "XXXX" is the performance name.
- (i) Using the PERFORMANCE MEMORY/FUNCTION switches, select the position to which you wish to move the data. The selected position will be displayed on the LCD display following the "TO"

- portion.
- * To move data from a cartridge to the internal memory (single load) turn off cartridge access using the CARTRIDGE switch and select the position to which you wish to move the data.
 - * To move data from the internal memory to an external RAM cartridge press the CARTRIDGE switch to enable access from the internal memory to the cartridge, and select the position to which you wish to move the data.
 - * When attempting to move internal data to a RAM cartridge, if a cartridge formatted for VOICE MEMORY (=00) is inserted instead of one formatted for PERFORMANCE MEMORY (=01) the *****ERROR** Cartridge format conflict!** message will be displayed when the CARTRIDGE switch is pressed. Be sure to use a cartridge which has been formatted for PERFORMANCE MEMORY (format = 01) using the FUNCTION mode CHANGE CART. FORMAT function. *-P.46*
- (j) Press the DATA ENTRY section YES button to begin the store operation. This completes the memory move process.
- * If the memory protect function is not turned off prior to the above operations, the *****ERROR** W-protected!** message will be displayed. In this case go back to step (a) and repeat the procedure.
 - * When moving internal data to a cartridge, or when moving data within a cartridge, be sure to turn the cartridge memory protect switch back ON after the operation.

Fig. 19. Moving Performance Memory

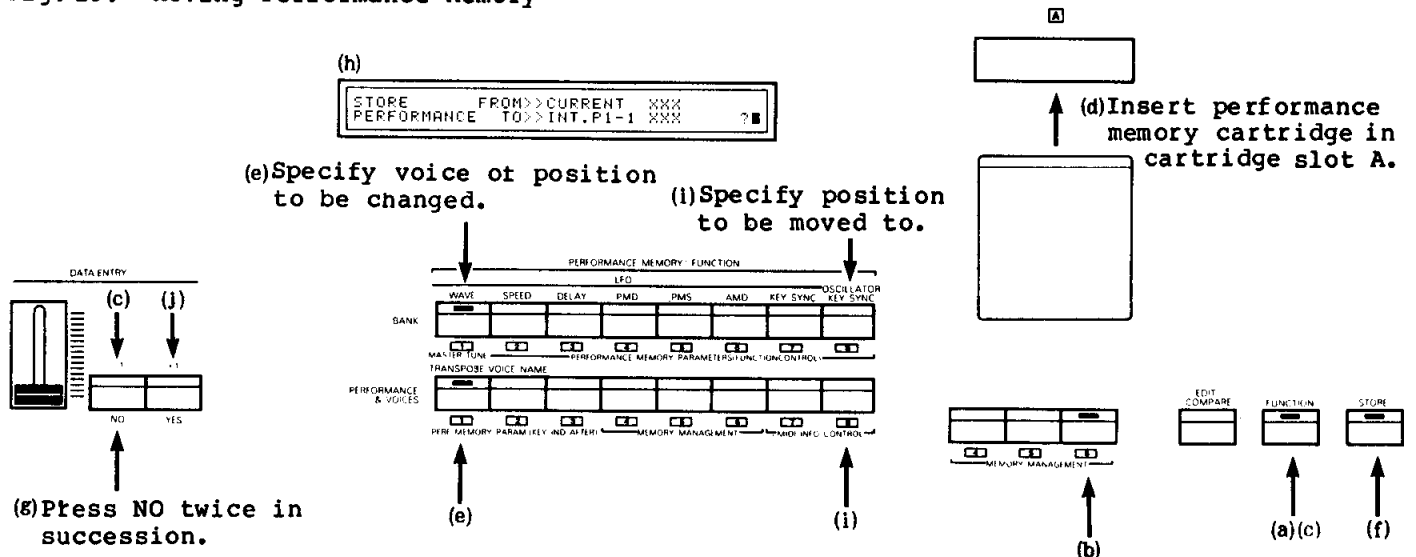

EDIT mode/VOICE PARAMETERS

In the EDIT mode, the VOICE MEMORY voice parameter data can be read into the VOICE EDIT BUFFER and edited. The vast number of parameters that can be edited permits extremely broad-ranging voice creation. After editing, the new data can be re-stored in the VOICE MEMORY.

4-1 The EDIT mode

(1) The EDIT process

In the EDIT mode, the many voice parameters in the VOICE MEMORY are read into a buffer and edited. Since the DX1 PERFORMANCE MEMORY settings are a part of the voice created, the PERFORMANCE MEMORY will also be involved in the editing process. The following two variations on the editing process are possible:

(I) The VOICE MEMORY for a specific voice is altered without changing the PERFORMANCE MEMORY.

(II) Both the edited VOICE MEMORY and PERFORMANCE MEMORY are re-stored as a new voice.

*** I:**
 Editing the VOICE MEMORY without changing the PERFORMANCE MEMORY.
 EDIT target selection = PERFORMANCE MEMORY selection ⇒
 Switch to EDIT mode ⇒
 Set data ⇒
 Store EDIT data = replace VOICE MEMORY.

*** II:**
 Re-storing both the edited VOICE MEMORY and the PERFORMANCE MEMORY as a new voice.
 EDIT target selection = VOICE MEMORY selection ⇒
 Switch to EDIT mode ⇒
 Set data ⇒
 Store EDIT data = Set new VOICE MEMORY and PERFORMANCE MEMORY.

(2) EDIT mode selection/Loading the buffer

*** I: PERFORMANCE MEMORY selection (fig. 20)**

This is for the case in which the VOICE MEMORY data is edited and re-stored while the PERFORMANCE MEMORY is left unchanged.

- (a) Turn all mode selectors (EDIT, FUNCTION, STORE) OFF.
- * It does not matter if the EDIT switch is flashing.
- * To edit RAM CARTRIDGE VOICES, first turn the cartridge memory protect OFF, then insert the cartridge into the cartridge

- slot.
- * After editing data from a ROM cartridge, the new voice can not be written back into the same cartridge.
- (b) Select the PERFORMANCE MEMORY position to be edited.
- * The PERFORMANCE MEMORY can not be re-selected once the EDIT mode is entered.

*** II: VOICE MEMORY selection (fig. 21)**

This is for the case in which both the edited VOICE MEMORY and PERFORMANCE MEMORY are re-stored as a new voice.

- (a) Turn all mode selectors (EDIT, FUNCTION, STORE) OFF.
- * It does not matter if the EDIT switch is flashing.
- * To edit ROM cartridge voice data, first set the switch on the cartridge to the appropriate bank, insert the cartridge in the cartridge slot and press the CARTRIDGE switch.
- * To edit RAM cartridge voice data and store the results in the same cartridge, first turn the cartridge MEMORY PROTECT switch OFF, insert the cartridge into the cartridge slot, then press the CARTRIDGE switch.
- * To edit RAM cartridge voice data and store the results in the internal memory, insert the cartridge into the cartridge slot with the MEMORY PROTECT switch ON, then press the CARTRIDGE switch.
- * If a PERFORMANCE MEMORY CARTRIDGE is inserted, the error message "***ERROR** Cartridge format conflict" will be displayed when the CARTRIDGE switch is pressed.
- (b) Select the VOICE MEMORY to be edited.
- * The selected VOICE MEMORY can not be changed once the EDIT mode has been entered.

Fig. 20. Selecting Performance Memory

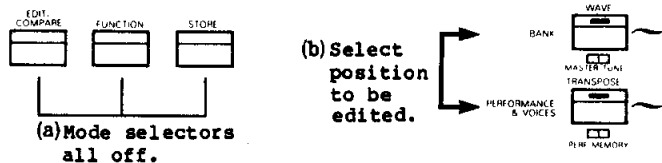
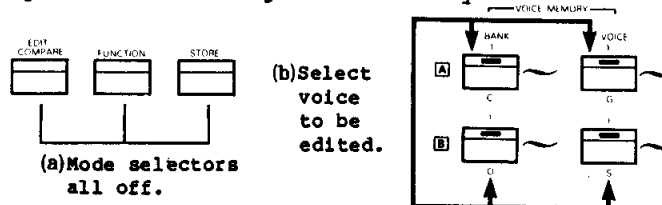

Fig. 21. Selecting Voice Memory



(3) Switching to the EDIT mode and Entering Data (Fig. 22)

- (c) Enter the EDIT mode using the EDIT/COMPARE switch. This makes it possible to alter the data in the EDIT BUFFER.
- (d) The VOICE MEMORY channel will automatically be selected, and the target EDIT voice indicator will flash.
- * If the KEY ASSIGN MODE switch is set to DUAL, sound will be output from both channels A and B. In order to monitor only the target EDIT voice, set the BALANCE slide control all the way to the corresponding channel.
- (e) The LED and LCD displays display the data for the target voice.
- * The leftmost operator select switch determines which individual operator data is displayed.
- * The LED display displays the data for the parameter shown below it.
- * The LCD display shows the data of parameter selected by the PERFORMANCE MEMORY/FUNCTION switch.
- (f) Select the parameter to be edited using the row of voice parameter switches below the LED display, or the PERFORMANCE MEMORY/FUNCTION switches.
- * The voice parameter switches include most of the FM tone generator and operator functions that are essential for voice creation. →P.21
- * The PERFORMANCE MEMORY/FUNCTION switches include LFO modulation-related effects that affect all operators simultaneously. →P.27
- * Envelope generator voice parameter K1 is automatically selected. Simply press the appropriate switch to select another parameter.
- (g) Set the desired data value using the DATA ENTRY section.
- * Data can also be set by continuously pressing the selected (flashing)

PARAMETER switch.

- * Use the COMPARE switch to compare the sound of the edited data with the sound of the original data. →P.21
- (h) To set the parameters for each operator, use the OPERATOR SELECT switches to select the operator to be worked on. →P.21
- * Using the OPERATOR ON/OFF switches it is possible to concentrate on a single operator, permitting extremely fine sound control. →P.22
- (i) After editing on one channel has been completed, switch over to the other channel and perform any necessary editing on that channel. Either channel can be selected by pressing a bank or voice switch of the channel you wish to select.
- * Also set the balance slider all the way to the appropriate channel.

(4) Storing Edit Data

In order to store edit data, a store operation must be performed. Two processes are possible: (I) Storing data without changing the memory position, and (II), storing data in a new VOICE MEMORY or PERFORMANCE MEMORY position.

- * Each time power to the DX1 is turned on, the internal memory protect system is activated in order to prevent accidental memory erasure. This function must be turned off in order to perform a store operation.
- * When a store operation is performed, data originally in the memory to which the store is performed will be erased. Data which needs to be saved should therefore be stored in an external RAM cartridge. →P.45
- * In order to store edit data on an external cartridge, a cartridge formatted for VOICE MEMORY storage must be used. A cartridge formatted for PERFORMANCE MEMORY cannot be used.

Fig. 22. Switching to Edit Mode and Entering Data

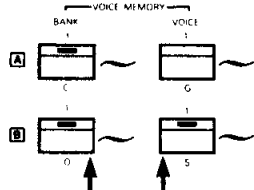
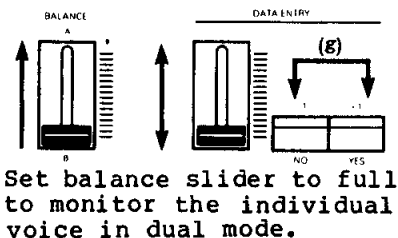
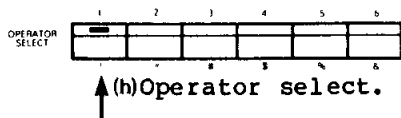

- (d) Voice selected for editing flashes.
- (i) Edit another channel voice by pressing the voice or bank switch to change channel.

(e) LED display

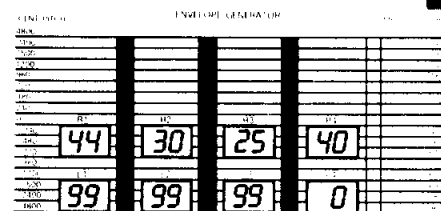

Parameter switch

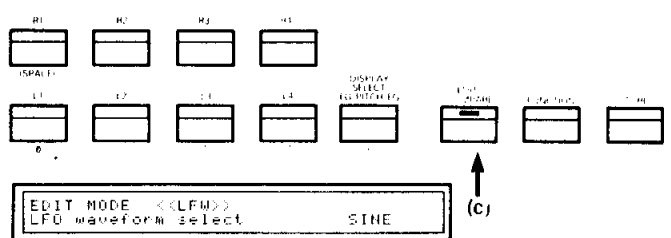

*** I: Replacing an Original VOICE MEMORY (fig. 23)**

In order to re-store edited data in the original memory location, use the STORE ALL function (the VOICE MEMORY and PERFORMANCE MEMORY are simultaneously re-stored in their original locations).

- * Using the STORE ALL function it is not possible to move data to another memory location, move data from one channel to another, or move data from the internal memory to an external cartridge.
- * The STORE ALL function makes it possible to store internal VOICE MEMORY data back into the same internal memory location, or to store cartridge memory data back into the same cartridge memory location. →P.53
- (j) In order to defeat the memory protect function, switch to the FUNCTION mode.
- (k) Call the protect memory write function.
- (l) When the LCD display reads "Internal memory write protect ON", press the DATA ENTRY NO key, causing the display to read "Internal memory write protect OFF". This defeats the memory protect function.
- * If you attempt a store operation with the memory write protect function ON, the "***ERROR** W-protected!" message will be displayed and storing will not be possible.
- * The STORE VOICE function can be used if PERFORMANCE MEMORY data has not been changed.
- (m) If the store switch is used to enter the STORE mode, the "STORE ALL FROM >> CURRENT EDITING TO >> CURRENT SELECTED" message will be displayed. With the STORE ALL function the store position selection process is greatly shortened.
- (n) Press the DATA ENTRY YES button to begin the store operation.
- * Both channels A and B cannot be stored at the same time. The store operation must be performed on one channel at a time.
- * After the store operation be sure to turn the VOICE MEMORY or RAM cartridge memory protect function back on.

Fig. 23. Replacing Original Voice Memory.

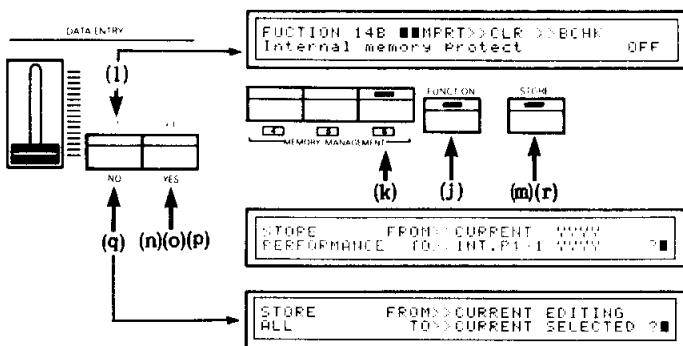

*** II: Storing in a New VOICE MEMORY or PERFORMANCE MEMORY (fig. 24)**

In order to store in a new VOICE MEMORY or PERFORMANCE MEMORY position, the STORE VOICE function (the store function which permits moving VOICE MEMORY data to a new memory location) is used. In addition the STORE PERFORMANCE function must be used. The STORE PERFORMANCE function is the function which permits moving PERFORMANCE MEMORY data to a new memory location.

- * To store to a new position in a RAM cartridge, or to store from a ROM or RAM cartridge to the internal memory (single load) insert the cartridge into the DX1 and press the CARTRIDGE switch.
- * If a PERFORMANCE MEMORY CARTRIDGE is used the "***ERROR** Cartridge format conflict!" message will be displayed when the CARTRIDGE switch is pressed.
- * To store from the internal memory to a RAM cartridge (single save) insert the cartridge into the cartridge slot and turn the CARTRIDGE switch OFF.
- (j) Switch to the FUNCTION mode.
- (k) Call the protect memory write function.
- (l) Press the DATA ENTRY section NO button.
- (m) Switch to the STORE mode and press the DATA ENTRY NO switch causing the "STORE VOICE FROM >> EDITING WWWW TO >> INT A1-1 WWWW" message to be displayed.
- * "INT-A1-1" is the memory position, and "WWW" is the voice name.
- (n) The VOICE MEMORY and bank 2nd voice switches are then used to set the store destination. The destination position is displayed following "TO" on the LCD display.
- * When storing from a cartridge into the internal memory select the destination location after the CARTRIDGE switch has been turned OFF.
- * When storing from the internal memory to a RAM cartridge, select the destination location after the CARTRIDGE switch has been turned ON.
- * If a PERFORMANCE MEMORY CARTRIDGE is used, the "***ERROR** cartridge format conflict!" message will appear when the cartridge switch is pressed.
- (o) Pressing the DATA ENTRY YES button begins the actual store operation.
- * Store voice can only be performed on one channel at a time. After performing the store operation on one channel,

Fig. 24. Storing New Voice and Performance Memory

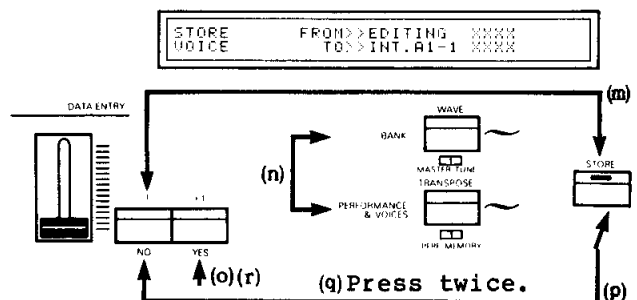

- press the lighted VOICE MEMORY selector to switch to the other channel, then perform operations (m)--(o) once again.
- * In the case of a RAM cartridge, always remember to turn the memory protect switch back ON after the store operation.
 - (p) When effect data is also to be stored in the internal PERFORMANCE MEMORY, call the STORE mode one more time.
 - (q) press the DATA ENTRY NO button twice, causing the "STORE PERFORMANCE FROM >> CURRENT YYYY TO >> INT P1-1 YYYY" message to be displayed.
 - * "INT P1-1" is the memory position, and "YYYY" is the performance name.
 - (r) Press the DATA ENTRY YES key to begin the store operation.
- Caution: Voice data is not stored if a STORE PERFORMANCE operation is performed without storing to VOICE MEMORY.

(5) The Compare Function (fig.25)

This function permits comparing the original sound of a voice with the current sound of the edited voice while in the EDIT mode.

- (a) After changing even a single parameter in the EDIT mode, pressing the EDIT/COMPARE switch a second time activates the compare mode. This recalls the original voice data and sound permitting checking and comparison throughout the edit process.
- * In the compare mode, the VOICE MEMORY and edit parameter switches stop flashing, and the EDIT/COMPARE switch begins to flash.
- * If the EDIT mode is entered and the EDIT/COMPARE switch is pressed again before any parameter changes are made, the EDIT mode is exited.
- (b) To resume edit operation from the compare mode, simply press the EDIT/COMPARE switch again.
- * The EDIT and COMPARE modes alternate each time the EDIT/COMPARE switch is pressed.
- (c) It is possible to exit the edit process while in the compare mode, cancelling any parameter changes which have been made. In this case, simply press a different VOICE MEMORY or PERFORMANCE MEMORY switch while the EDIT/COMPARE switch is flashing.

Fig. 25. Compare Function

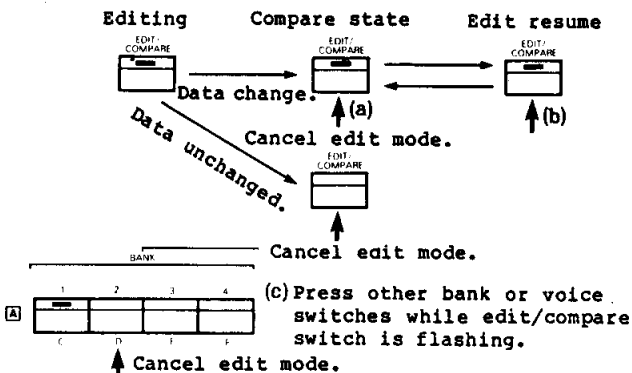

(6) The Data Recall Function

A data recall function has been included to provide a "backup" if erroneous data is accidentally entered during a compare operation. It is possible to recall the data using the RECALL EDIT BUFF function in the FUNCTION mode. -P.45

- * If a different VOICE MEMORY or PERFORMANCE MEMORY button is pressed during a compare operation, the EDIT mode is exited and the edit data display is lost. However, the data is still in the buffer memory and can be recalled using the RECALL EDIT BUFF function.

4-2 The Voice Parameter Buttons Below the LED Display

All the parameters which are required for the creation of voices are incorporated in the voice parameter switches arranged below the LED display. These parameters can be broadly classified into the following three function groups:

- All operator functions (can be memorized)
- Single operator functions (can be memorized/*)
- Operation only functions (cannot be memorized/**)

ALGORITHM (fig. 26)

The DX1 has two FM tone generator sections--channel A and channel B. Each of these incorporates 6 operators. In this section it is possible to set up the operator combinations to form the desired algorithm (the modulator-carrier relationship between the operators). This is the basis for all voice creation.

(1) OPERATOR SELECT **

These switches permit selection of an operator to be worked on in the EDIT mode. When one of these switches is turned on its indicator will light. When working on one operator at a time, use these switches to select the operator to be edited as required.

- * When an individual operator is selected the data concerning that operator is displayed on the LED display.
- * When the power is initially turned ON, operator 1 is automatically selected.
- * The operator selector status cannot be stored in the VOICE MEMORY.

Fig. 26. Algorithm Section

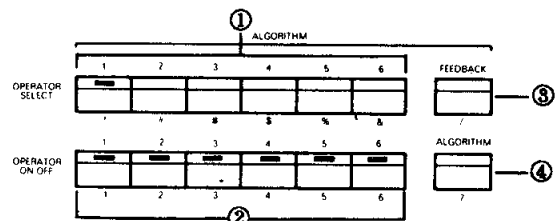

(2) OPERATOR ON/OFF **

These switches permit turning operators 1--6 ON or OFF. When an indicator is ON the corresponding operator is ON. When an indicator is OFF the corresponding operator is OFF.

- * If all operators but the one being worked on are turned OFF while editing, checking the details of operator parameters is easier.
- * If all the operator ON/OFF switches are turned OFF, no sound will be output.
- * All operators are automatically turned ON when power to the DX1 is initially turned ON.
- * The operator ON/OFF switch status cannot be stored in the VOICE MEMORY.

(3) FEEDBACK: 0--7

This function permits an operator to modulate itself with no relationship to carrier-modulator functions. In general this function makes it possible to create brighter sounds and sounds with noise-like characteristics. Operators which can have feedback are pre-determined in each algorithm pattern.

- * On the LED display, operator numbers with a dot to their lower right-hand corner can have feedback applied (fig. 27).
- * The algorithm patterns are printed on the display panel to the left of the LED display. Operators indicated with a loop-like line printed from their output back to their input are operators to which feedback can be applied (fig. 28).
- * By applying feedback, harmonics are generated within a single operator, performing the function normally carried out by combination of two or more operators. If an operator to which feedback is applied is used as a modulator, not only does the carrier generate a greater number of harmonics, the distribution of the harmonic

Fig. 27. LED Display: Algorithm and Feedback Positions

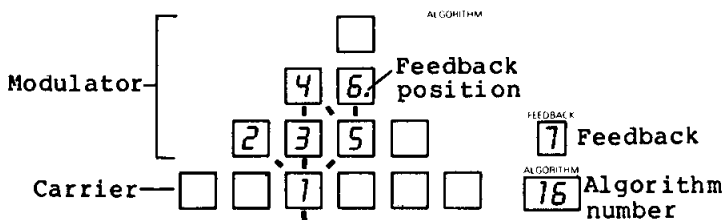
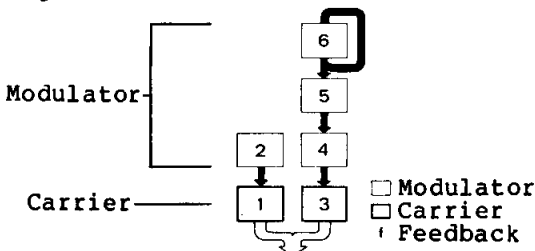

Fig. 28. Feedback



spectrum is more uniform. This also makes it possible to create white-noise type sounds with an even harmonic distribution throughout the entire frequency spectrum. -P.68

- * Feedback level can be set between 0 and 7. At 0 feedback is OFF, and at 7 feedback is maximum.

(4) ALGORITHM: 1--32

This permits selection of the algorithm which is most appropriate for the voice to be created from the 32 algorithm types which are provided.

- * The selected algorithm is shown on the LED display. The lowest row of operators function as carriers. All higher rows of operators are modulators (fig. 27).
- * All algorithm patterns are printed on the display panel to the left of the LED display. The lowest row of operators in each algorithm are carriers, and all operators above these are modulators.
- * Although a large number of algorithms are provided, generally speaking algorithms with fewer carriers and a greater number of modulators produce the strongest sound variation. In addition, noise-like characteristics are easier to produce. On the other hand, an algorithm with more carriers lends itself to richer, thicker sounds. -P.69

OSCILLATOR (fig. 29)

This section permits setting the pitch data for each operator in the FM tone generators. This section functions to set the pitch and basic sound.

(5) MODE*

This permits setting the oscillator mode (FREQUENCY RATIO/FIXED FREQUENCY).

FREQUENCY RATIO

- * This is the normal mode in which operator pitch varies according to the

Fig. 29. Oscillator Section

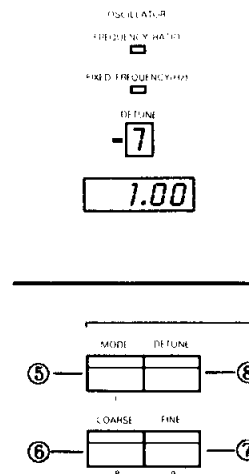

key pressed. The operator pitch is set at a 0.50--61.69 ratio in relation to the keyboard standard pitch (8').

- * If all operators are set to this mode then the harmonic content of the sound is the same regardless of the pitch.

FIXED FREQUENCY

- * This mode permits fixing the operator frequency. Operator pitch can be set between 1 Hz and 9770 Hz.
- * If all operators are set to this mode then the pitch of the sound will not change regardless of the key pressed. The fixed frequency mode is useful for creating sounds with no pitch variation, such as bells and noise. It can also be used when the pitch of one operator is set extremely low in order to modulate the carriers to produce a vibrato effect.

(6) COARSE* (7) FINE*

These functions set the pitch of each operator.

- * For operators which are functioning as carriers this determines the keyboard pitch (footage), and for operators which are operating as modulators it determines the harmonic spectrum of the resultant sound. -P.67
- * When the operator being adjusted is a modulator, raising the pitch increases high-frequency harmonic content for a brighter, sharper sound.
- * If the pitch of a modulator is varied only slightly from that of the carrier which it is modulating, low frequency harmonics are generated as well as high frequency harmonics, resulting in a "pitchless" sound.
- * The data control increments are different according to the oscillator mode setting.

FREQUENCY RATIO mode

Data is input as a ratio in relation to standard keyboard pitch.

COARSE
0.50--31.00 (FINE at MIN: 1.00 increments)
0.99--61.69 (FINE at MAX: 1.99 increments)
FINE (COARSE increments x 1/100)
0.50--0.99 (COARSE at MIN: 0.01 increments)
31.00--61.69 (COARSE at MAX: 0.31 increments)

The DX1 standard keyboard pitch is 8'. Therefore, in terms of footage, 0.50=16', 1.00=8' and 2.00=4'.

FIXED FREQUENCY mode

Data is input as a frequency.

COARSE
1.000--1000 Hz (FINE at MIN: x10=10/3 oct=4000 cent increments)
9.770--9770 Hz (FINE at MAX: x10=10/3 oct=4000 cent increments)
FINE (COARSE increments x 1/100)
1.000--9.770 Hz (COARSE at MIN: 1/30

oct=40 cent increments)
1000--9770 HZ (COARSE AT MAX: 1/30
OCT=40 cent increments)

(8) DETUNE*: -7 -- +7

This function slightly detunes the pitch of each operator in relation to the others, creating a deep, full sound.

- * Detune data can be set over a -7 -- +7 range (maximum detune=±2 cents). For example, if the frequency ratio is set at 1.00, a maximum pitch variation of 1.2 Hz will be produced when the C3 key is pressed.
- * If detune is applied to operators acting as carriers, a slight pitch variation is produced, resulting in a "multi-instrument" sound.
- * If detune is applied to operators acting as modulators, a slight phase shift variation is introduced causing a periodic timbre variation.

ENVELOPE GENERATOR (fig. 30)

The distinct character of a musical instrument is determined not only by its harmonic content, but by the way its level, pitch and harmonic content vary with time. The ENVELOPE GENERATOR permits programming all these elements for any voice.

- * The EG sets the time-based variation of level and timbre, while the PITCH EG sets time-based variation of pitch.
- * The EG and PITCH EG both offer 8 variable parameters, compared to the 4 variable parameters available with conventional ADSR type envelope generators.

(9) RATE 1--4*: 1--99

(10) LEVEL 1--4*: 0--99

These switches select the desired EG or PITCH EG parameter.

Fig. 30. Envelope Generator Section

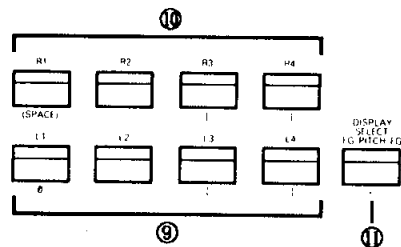

EG (fig. 31)

This is the level and timbre envelope generator. It can be set individually for each operator.

Each parameter functions as follows:

- R1 (Rate 1): the time it takes to reach Level 1 after a key is pressed.
- R2 (Rate 2): the time it takes to reach Level 2 from Level 1.
- R3 (Rate 3): the time it takes to reach Level 3 from Level 2.
- R4 (Rate 4): the time it takes to reach Level 4 after a key is released.

- (e) L1 (Level 1): the initial level when a key is pressed.
- (f) L2 (Level 2): an intermediate level between Level 1 and Level 3.
- (g) L3 (Level 3): The sustain level maintained while a key is held.
- (h) L4 (Level 4): The basic level returned to after a key is released.
- * For the RATE parameter: 99 is the fastest rate and 0 is the slowest.
- * LEVEL determines the operator level at each point along the EG curve. LEVEL is determined by setting the required amount of attenuation (-dB). Operator LEVEL is maximum when set at 99, and minimum when set at 0 (-96 dB).
- * If a carrier L4 is set to any value greater than 1, sound will continue to be output even if no keys are pressed.
- * When the EG is not to be used, set L1, L2, and L3 to 99, and L4 to 0. (The initial voice data settings are: L1--L3=99, L4=0, R1--R4=99) →P.44
- * Since in the FM tone generator system the carriers control pitch and level while the modulators control timbre, applying the EG to a carrier results in a corresponding level variation, while applying EG to a modulator results in a timbre variation.
- * Figure 48 shows an example of a piano carrier envelope. Figure 49 is an

organ carrier envelope, and figure 50 is a brass wind instrument modulator envelope.

- * The EG parameters can be set independently for each operator. However, when there will not be a great difference between the EG settings for each operator, the FUNCTION mode COPY OPERATOR DATA function can greatly shorten the EG setup process. →P.42
- * When the sustain footswitch is used, all EG parameters come into play. For example, when the footswitch is pressed, the key-on state is held and the EG responds accordingly--i.e. if L3 is set at 99, the sound will continue at that level as long as the footswitch is held. When the footswitch is released (and no keys are pressed) to sound returns to L4 at the rate determined by R4 (fig. 51a). If L3 is set between 1 and 98, then the sound level will reach L3 at the rate R3 when the keys are all released, then the level will return to L4 at rate R4 when the footswitch is released (fig. 51b). If L3 is set to 0, then the sound will decay towards 0 at rate 3 when the keys are released, and the decay rate will switch to R4 when the footswitch is released (fig. 51c). If L3=0, R3=99 and R4=99, no sustain effect can be produced. Further, when L2=L3=1--99, the L2 & L3 level will be held as long as the footswitch is held. →P.37

Fig. 31. DX1 Basic EG Pattern

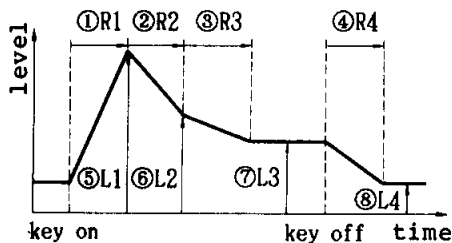

Fig. 32. Piano Carrier Envelope

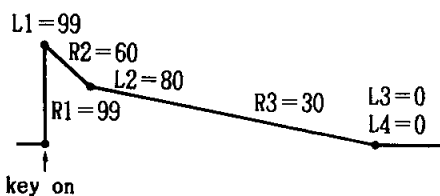

Fig. 33. Organ Carrier Envelope

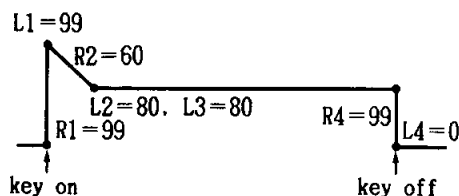

Fig. 34. Brass Carrier Envelope

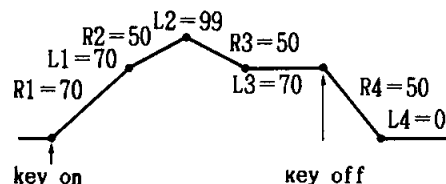
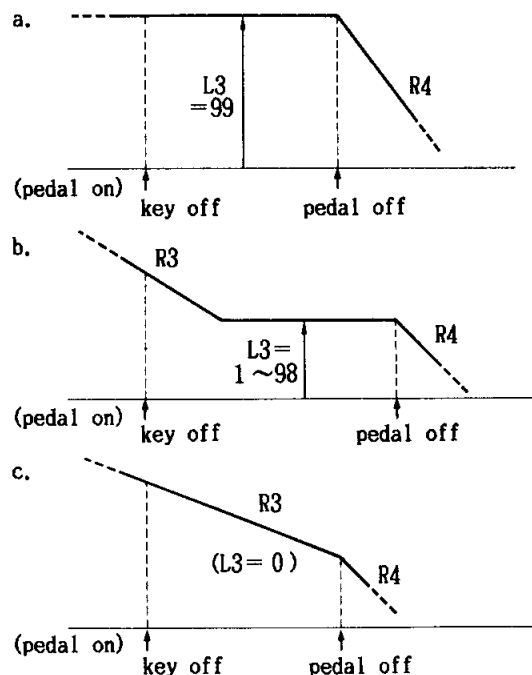

Fig. 35. Sustain Effect



PITCH EG (fig. 36)

The pitch EG affects all operators simultaneously, permitting application of an overall pitch envelope. The PITCH EG parameters are as follows:

- (a) R1 (Rate 1): the time it takes to reach Level 1 pitch after a key is

pressed.

- (b) R2 (Rate 2): the time it takes to reach Level 2 pitch from Level 1.
- (c) R3 (Rate 3): the time it takes to reach Level 3 pitch from Level 2.
- (d) R4 (Rate 4): the time it takes to reach Level 4 pitch after a key is released.
- (e) L1 (Level 1): the initial pitch when a key is pressed.
- (f) L2 (Level 2): an intermediate pitch between Level 1 and Level 3.
- (g) L3 (Level 3): The sustain pitch maintained while a key is held.
- (h) L4 (Level 4): The pitch returned to after a key is released.

- * For the RATE parameters, 99 is the fastest and 0 the slowest.
- * For the LEVEL parameters, 50 corresponds to standard keyboard pitch, 0 is -4 octaves, and 99 is +4 octaves.
- * When the PITCH EG is not to be used, L1--L4 should all be set to 50. (The initial voice data is: L1--L4=50, R1--R4=99). →P.44

* The PITCH EG is useful not only for creating musical instrument sounds, but also for synthesizing the sounds of animals, whistling, or any sound effect that has a distinctive pitch variation.

Fig. 36. DX1 Basic Pitch EG Pattern

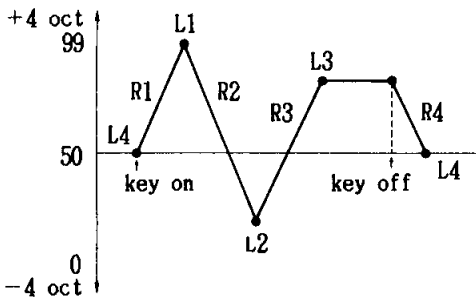

(11) DISPLAY SELECT ** :EG/PITCH EG

This switch determines whether the LED display displays the values of the EG or PITCH EG parameters.

- * EG parameters R1--R4 and L1--L4 are all displayed in numeric (digital) form. A bar graph display also provides a graphic indication of the EG curve.
- * The bar graph has scales for both amplitude (-dB) and cents (pitch. 100 cents = semitone). The cents scale for the PITCH EG is printed to the left of the bar graph, and the amplitude scale for the EG is printed to the right of the bar graph (fig. 53).

Fig. 37. EG LED Display

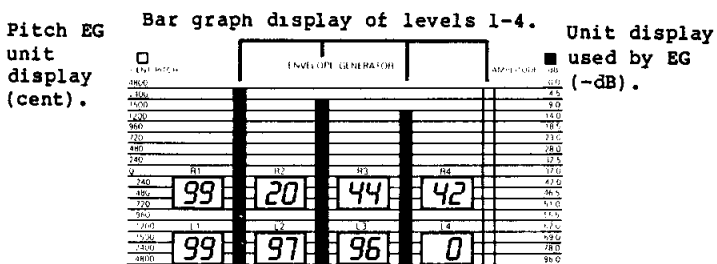

* The position of the display select switch can not be stored in memory.

KEYBOARD SCALING (fig. 38)

The high and low frequency ranges of acoustic instruments generally do not have the same level or timbre envelope. This balance between the low and high frequency range envelopes has been developed over literally centuries, and that is why the sound of an acoustic instrument is so pleasing to the ear. The DX1 KEYBOARD SCALING function allows synthesizing this kind of envelope variation. A natural, pleasing overall response can be produced by varying the way in which the EG is applied at different frequencies. The KEYBOARD SCALING feature has two functions--LEVEL SCALING and RATE SCALING.

Fig. 38. Keyboard Scaling Section

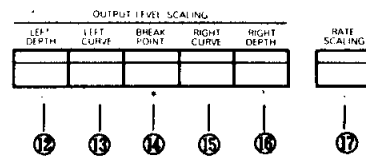

LEVEL SCALING (fig. 39)

This function varies the EG level according to the key played. Since this can be applied to each operator individually, it can be used to control level and timbre. The LEVEL SCALING function has 5 parameters, permitting creation of a broad variety of scaling characteristics. The 5 parameters are:

- (a) BREAK POINT: This sets the key which is to be the center point of the scaling curve.
- (b) LEFT CURVE: This sets the level scaling curve to the left of the BREAK POINT.
- (c) RIGHT CURVE: This sets the level curve to the right of the BREAK POINT.
- (d) LEFT DEPTH: This sets the depth of the scaling effect to the left of the BREAK POINT.

Fig. 39. Level Scaling

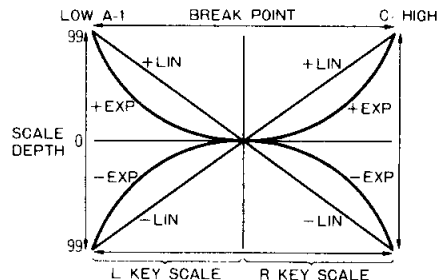
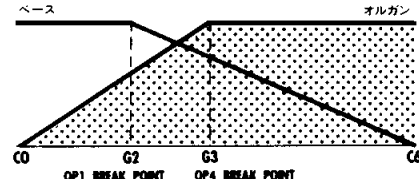

Fig. 40. Simulated Keyboard Split with Level Scaling



(e) RIGHT DEPTH: This sets the depth of the scaling effect to the right of the BREAK POINT.

- * LEVEL SCALING is very effective in creating natural-sounding acoustic instrument voices.
- * As shown in figure 56, LEVEL SCALING permits the creation of completely different timbres for the low and high frequency ranges.

(12) LEFT DEPTH * : 0--99

This sets the depth of the LEVEL SCALING effect to the left of the BREAK POINT.

- * The data range is 0--99. At 0 LEVEL SCALING is OFF, and at 99 maximum level variation is produced.
- * The depth setting can not cause operator level to exceed the level at which the OPERATOR OUTPUT LEVEL parameter is set (maximum OPERATOR OUTPUT LEVEL = 99). Depth data set for an output level greater than the OPERATOR OUTPUT LEVEL setting will result in a maximum output level equal to the OPERATOR OUTPUT LEVEL setting.

(13) LEFT CURVE * : +LIN/+EXP/-LIN/-EXP

This sets the LEVEL SCALING curve to the left of the BREAK POINT.

- * One of the following four curves can be selected:
 - + LIN: This is a linear level increase, and produces the largest audible variation.
 - + EXP: This is an exponential increase, which produces a gentler variation.
 - EXP: This is an exponential decrease in level. Gentle variation.
 - LIN: This is a linear decrease in level. Large audible variation.
- * The selected curve lights on the LED display.

(14) BREAK POINT * : 0--99

This sets the key which is to be the "center" of the level scaling curve. It is possible to set different scaling characteristics for the keyboard sections to the left and right of the BREAK POINT.

- * The key selected to be the break point is not affected by level scaling.
- * The data range is 0--99. 0=A-1, 99=C8. This means that the BREAK POINT can be set at any half-tone interval on the keyboard.
- * Since the keyboard range is from E0 to E6, it is possible to set the BREAK POINT outside the keyboard range.

(15) RIGHT CURVE * : +LIN/+EXP/-LIN/-EXP

This sets the LEVEL SCALING curve to the right of the BREAK POINT.

- * The functions are the same as for LEFT CURVE, described above.

(16) RIGHT DEPTH * : 0--99

This sets the LEVEL SCALING depth to the right of the BREAK POINT.

- * The functions are the same as for LEFT DEPTH, described above.

RATE SCALING (fig. 41)

This function makes it possible to set the EG rate so that it increases as higher notes are played on the keyboard. That is, the higher the note played, the faster the EG rate. Only a single parameter is available for this function--DEPTH--however, it can be set individually for each operator, so both level and timbre can be controlled.

- * RATE SCALING makes it possible to synthesize the sound of some string instruments, like piano and guitar, which have much faster response in the high frequency ranges (fig. 42).

(17) RATE SCALING * : 0--7

This sets the depth of RATE SCALING.

- * When a RATE SCALING value is set, the EG rate increases as higher notes are played through the A-1 to F#7 keyboard range. The EG rate is constant for all notes above F#7 (fig. 41).
- * The data range is 0--7. At 0 RATE SCALING is OFF, and at 7 RATE SCALING is maximum (highest EG rate).

Fig. 41. Rate Scaling

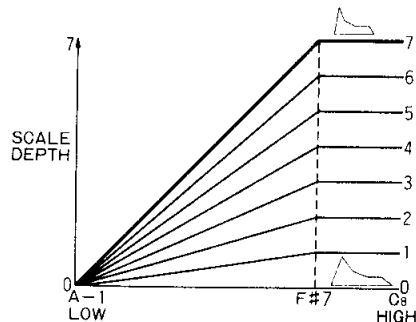
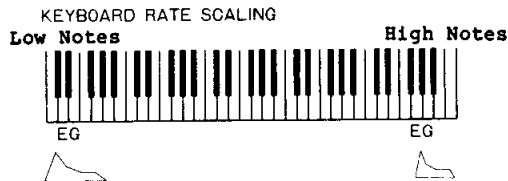

Fig. 42. Rate Scaling Function



Creates envelope effect: low note section sounds are long, high note section sounds are short.

SENSITIVITY (fig. 43)

This is a master parameter which sets the sensitivity of KEY VELOCITY (initial touch) and AMPLITUDE MODULATION (tremolo, etc.).

(18) KEY VELOCITY * : 0--7

This function makes it possible to set natural touch response (initial touch) such that the harder a key is played, the louder the sound and the brighter the timbre, etc. "How hard" the key is played is actually sensed by detecting key velocity.

- * This can be set independently for each

- operator. When applied to a carrier the result is a level variation, and when applied to a modulator the result is a timbre response variation.
- * The data range is 0--7. At 0 the function is OFF, and at 7 sensitivity is maximum.
 - * Throughout the range 0--6 sensitivity can not be set so that the maximum level produced when a key is played exceeds the OPERATOR OUTPUT LEVEL parameter setting. When sensitivity is set to 7, however, actual maximum output level can exceed the OPERATOR OUTPUT LEVEL setting by a maximum of 4 dB.

Fig. 43. Sensitivity Section

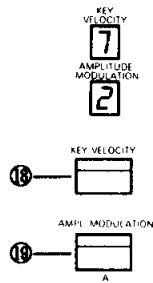

(19) AMPL. MODULATION * : 0--3

This master parameter sets the sensitivity of LFO modulation for tremolo and wow type effects, and EG BIAS for expression and brilliance effects (fig. 44). This feature works by varying operator output level.

- * AMPLITUDE MODULATION sensitivity can be set individually for each operator.
- When applied to a carrier the result is a level variation, and when set for a

Fig. 44. LFO Modulation Functions

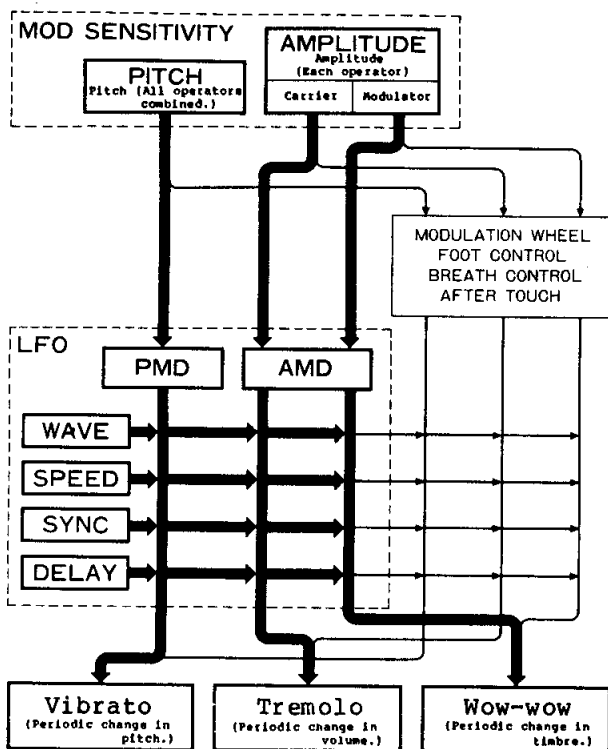

modulator the result is a timbre variation.

- * In the case of LFO modulation, when applied to a carrier the result is tremelo, and when applied to a modulator the result is a wow effect. The EDIT mode AMD parameter and FUNCTION mode controller parameters (MODULATION WHEEL, FOOT CONTROLLER, AFTER TOUCH, BREATH CONTROLLER) can be used for the control and application of LFO modulation. -P.38
- * In the case of EG BIAS, if applied to a carrier the result is volume control, and when applied to a modulator the result is brilliance control. The four controllers programmable in the FUNCTION mode can be used to control and apply EG BIAS modulation. -P.38
- * The data range is 0--3. 0=OFF, 3=maximum (maximum variation is 48 dB).
- * If AMPLITUDE MODULATION is set to 0 for all operators, tremolo, wow and brilliance effects can not be achieved.

(20) OPERATOR/OUTPUT LEVEL : 0--99 (fig. 45)

This independently sets the output level of each operator in the FM tone generators.

- * When adjusted for operators which are functioning as carriers the overall level is determined as well as the mixing balance between operators. When adjusted for a modulator the result is a difference in the harmonic spectrum generated, and therefore a difference in the timbre of the sound produced.
- * Data range is 0--99. The level set is displayed on a bar graph type readout on the LED display. Initial voice data for OPl, for example, is 99, which corresponds to a level of -10 dBm.

Fig. 45. Operator/Output Level

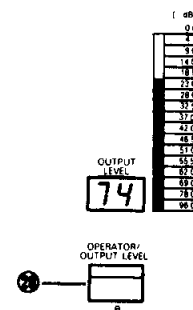

4-3 PERFORMANCE MEMORY/FUNCTION SECTION VOICE PARAMETERS

A number of voice parameters are also available in the PERFORMANCE MEMORY/FUNCTION switch group. These are LFO MODULATION parameters, OSCILLATOR KEY SYNC, KEY TRANSPOSE and VOICE NAME parameters.

- * The voice parameters are available in the upper-row buttons 1--8, and the lower-row buttons 1 and 2. The lower-row buttons 3--8 are inactive.
- * When these parameters are called the LCD display will read "EDIT MODE <<VVVV>>

WWWW (XX-YY) ZZ" (fig 46). "VVVV" is the function abbreviation, "WWWW" is the function name, "(XX--YY)" is the data range, and "ZZ" is the data.

* All the voice parameters in this section apply to all operators simultaneously.

Fig. 46. LCD Display: Edit Data

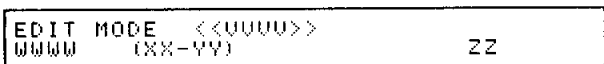

LFO (fig. 47)

LFO stands for Low Frequency Oscillator. It generates the low-frequency signals necessary to produce tremolo, wow and vibrato type effects.

* LFO MODULATION is controlled through the PMS (PITCH MODULATION SENSITIVITY) function in this block, and the AMPLITUDE MODULATION (fig. 59) function in the SENSITIVITY block.

Fig. 47. Details of Performance Memory/Function Section Voice Parameter Switches

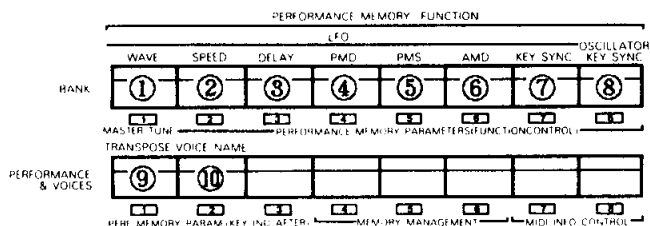

(1) WAVE : TRIANGLE/SAW DOWN/SAW UP/SQUARE/SINE/S. HOLD

This selects the LFO waveform. All operators are affected simultaneously.

* Six waveforms are available (fig. 48).

TRIANGLE: This produces a very clear periodic modulation effect. Ideal for tremolo.

SAW DOWN: (Sawtooth) An effect like a periodic drop in the sound.

SAW UP: (Sawtooth) An effect like a periodic increase in the sound.

SQUARE: The sound periodically "jumps" between two levels.

SINE: Smooth variation. Ideal for wow and vibrato.

S. HOLD: (Sample and Hold) Random variation.

* The LCD will read "EDIT MODE <<LFW>> LFO waveform select XXXX". "XXXX" is the waveform name.

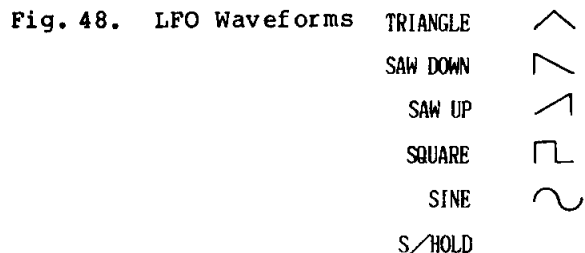

(2) SPEED : 0--99

This sets the LFO speed. All operators are affected simultaneously.

* Data range is 0--99. 0 is the slowest speed (0.06 Hz), and 99 is the highest speed (50 Hz).

* The LCD display will read "EDIT MODE <<LFS>> LFO speed (0-99) XX". "XX" is the data.

(3) DELAY : 0--99

This sets the delay between the time a key is pressed and time when LFO modulation begins. All operators are affected simultaneously.

* DELAY is particularly effective when used with a vibrato effect.

* The data range is 0--99. 0=OFF. A setting of 99 produces approximately a 3 second delay.

* With longer delay settings, there is not only a delay before the LFO effect begins, the LFO "comes in" with a smooth increase in modulation level for exceptionally natural LFO effects (fig. 49).

* The LCD display will read "EDIT MODE <<LFD>> LFO attack delay time (0-99) XX". "XX" is the data.

(4) PMD : 0--99

Pitch Modulation Depth. This sets the depth of pitch variation produced by LFO modulation (vibrato). Unlike the FUNCTION mode controllers, this effect is always ON once set. All operators are affected simultaneously.

* The data range is 0--99. 0=OFF, At 99 maximum pitch variation is produced (when PMS=7, maximum variation is ± 1 octave = 1200 cents).

* The LCD display will read "EDIT MODE <<LPMD>> LFO pitch modulation depth (0-99) XX". "XX" is the data.

* When PMS is set to 0 no effect is produced.

* Even if PMD is set to 0, vibrato can still be applied using the FUNCTION mode controllers. -P.38

(5) PMS : 0--7

Pitch Modulation Sensitivity. This master parameter sets the vibrato depth (pitch modulation) as applied by the controllers set up in the FUNCTION mode. This sets the maximum depth of the PMD parameter in the same block, as well as the FUNCTION mode controllers (fig. 44). All operators are affected simultaneously.

* The data range is from 0 to 7. 0=OFF. 7=maximum pitch variation (when PMD is set to 99, pitch variation is ± 1 octave = 1200 cents).

* The LCD display will read "EDIT MODE <<LPMS>> LFO pitch modulation sens. (0-7) X". "X" is the data.

* Vibrato can not be applied if PMD is set to 0 and all the controller ASSIGN parameters in the FUNCTION mode are OFF.

Fig. 49. Delay Effect

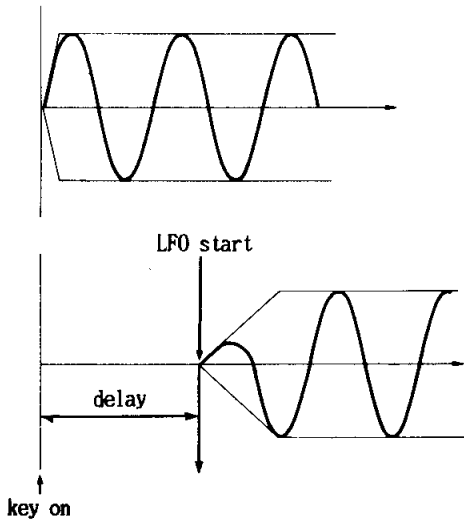

Fig. 50. Phase and Key Sync On/Off

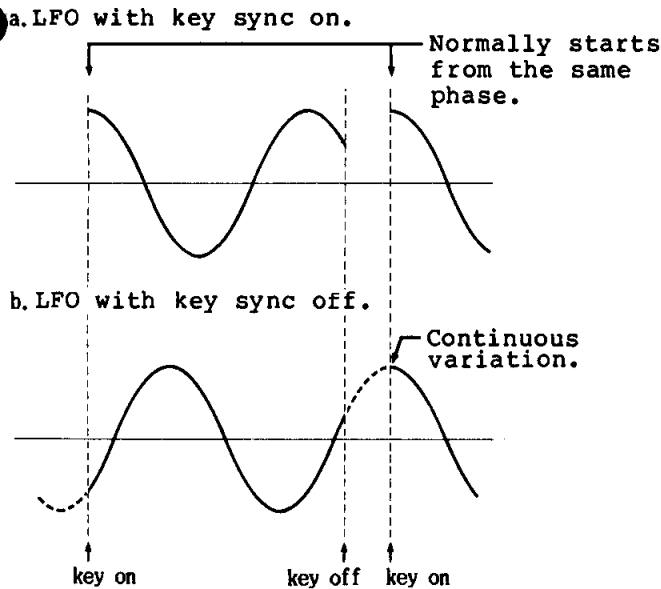
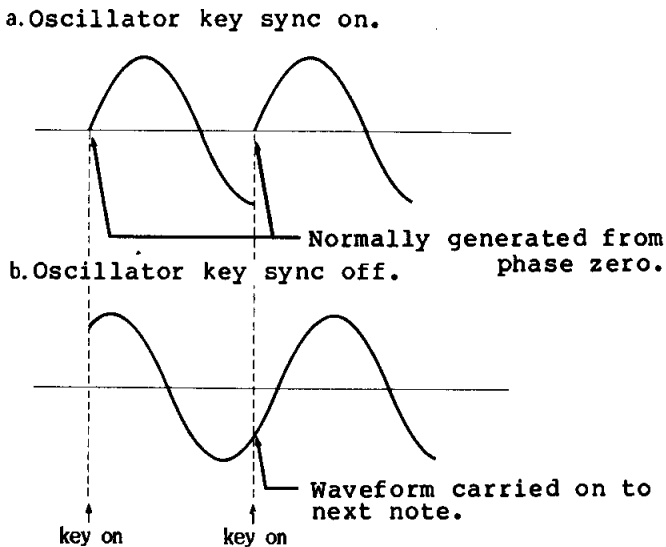

Fig. 51. Operator Waveform Phase and oscillator Key Sync On/Off



(6) AMD : 0--99

Amplitude Modulation Depth. This sets the depth of LFO modulation applied to operator output level to produce tremolo and wow effects. Effects set by this parameter are continuously ON and not affected by the FUNCTION mode controllers. All operators are affected simultaneously.

- * The data range is 0--99. 0=OFF, at 99 the level variation is maximum (when AMPL. MODULATION SENSITIVITY = 3, variation is 42 dB peak-to-peak).
- * The LCD display shows "EDIT MODE <<LAMD>> LFO amplitude mod. depth (0-99) XX". "XX" is the data.
- * No effect is produced when AMPL. MODULATION = 0.

(7) KEY SYNC : ON/OFF

Normally the beginning of the LFO cycle is synchronized with key-on timing. The KEY SYNC function permits turning this synchronization ON or OFF. All operators are affected simultaneously.

- * When ON, the LFO waveform begins from the same phase angle at key-on (90 degrees) (fig. 66a). This is ideal for sound effects which require a sharp attack.
- * When OFF, LFO/key synchronization is defeated (fig. 66b). When KEY SYNC is OFF, it is possible to create natural-sounding chorus, ensemble and rotary-speaker type effects.
- * The LCD display will read "EDIT MODE <<LFKS>> LFO key synchronize XX". "XX" is the data.

(8) OSCILLATOR KEY SYNC : ON/OFF (fig. 47)

Normally the output of all operators is synchronized with key-on timing. The OSCILLATOR KEY SYNC function permits turning this synchronization ON or OFF. All operators are affected simultaneously.

- * When OSCILLATOR KEY SYNC is ON, all operators begin output from the same phase angle (0 degrees) when a key is pressed. This is the normal mode of operation (fig. 51a). In this case, since all operators are at the same phase the sound is smooth and "unified". When the POLY (polyphonic) mode is set, however, the 17th note when the KEY ASSIGN mode is set to DUAL (16-note polyphonic), the 33rd note when the KEY ASSIGN mode is set to SINGLE (32-note polyphonic), and the 2nd note when the MONO mode is set, are likely to generate noise.
- * When OFF the operator waveform key-on synchronization is defeated (fig. 51b). This means that the timbre may be slightly different each time a key is pressed. No noise will be produced.
- * The LCD display will read "EDIT MODE <<OKS>> oscillator key synchronize XX". "XX" indicates the ON/OFF status.

(9) KEY TRANSPOSE : +24 -- -24 (fig. 47)

This function permits transposing the overall pitch of the keyboard. All operators are affected simultaneously.

- * The data range is +24 to -24. Each increment corresponds to a semitone step. With C3 as the reference pitch, this provides a ± 2 octave transposition range.
- * Normally this is set to +00 (reference pitch).
- * Data can be set simply by pressing a key on the keyboard. The key which is pressed takes on the reference pitch (C3), and the rest of the keyboard is transposed accordingly (fig. 53).
- * Pressing any key higher than C5 results in a +24 data setting, and pressing any key lower than C1 results in a -24 data setting.
- * Data can also be entered using the DATA ENTRY section.
- * Transpose data can not be altered using the keyboard. If the wrong key is pressed, the data must be altered using the DATA ENTRY section, or the KEY TRANSPOSE function must be re-entered.
- * If the DATA ENTRY section is used first, the keyboard can not be used to enter different data.
- * The LCD display will read "EDIT MODE <<TRNP>> Voice key transpose (direct key in) XX". "XX" is the data. "Direct key in" indicates that transpose data can be set using the keyboard.

Fig. 52. Key Transpose

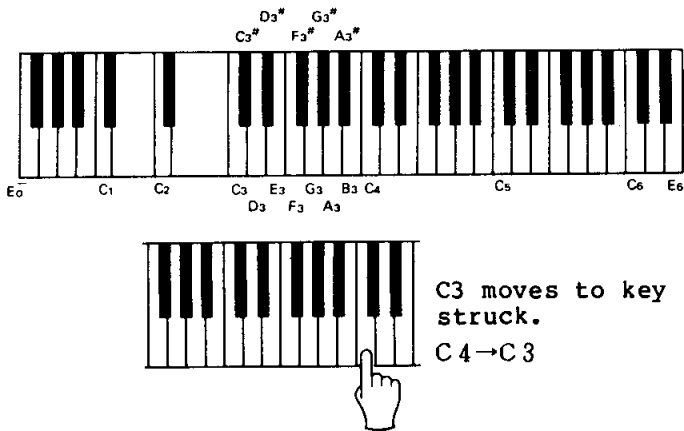

(10) VOICE NAME : 10 characters (fig. 47)

This function permits giving voices in the VOICE MEMORY a name of up to 10 characters in length.

- * The LCD will read "EDIT MODE <<VNAME>> Voice name ***XXXXXXXXXX***". The

"XXXXXXXXXXXX" portion of the display is the voice name. Characters are entered one at a time using the cursor (■).

- * Characters which can be used for naming voices are printed below the VOICE PARAMETER and VOICE MEMORY buttons. Pressing a button inputs the corresponding character which is then displayed at the appropriate position on the LCD display (fig. 53).

Fig. 53. Symbols and Characters for Use in Naming

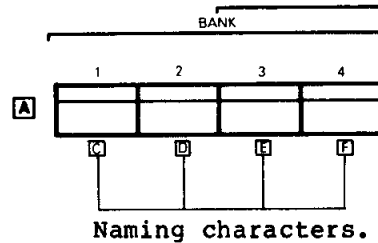

- * The cursor can be moved using the DATA ENTRY section + and - buttons.
- * In the PLAY mode, the channel A voice name is displayed on the upper row of the LCD display, and the channel B voice name is displayed on the lower row ("INT A1-1 XXXX POLY SRC=0 INT B1-1 XXXX POLY SRC=0"). "XXXX" is the voice name, and "INT A1-1" and "INT B1-1" are the VOICE MEMORY positions. Data following the "POLY" portion of the display is PERFORMANCE MEMORY data.
- * For "empty" memory positions in a VOICE RAM CARTRIDGE in which no voice is stored, the "====" symbol is displayed.
- * In the DX1 it is possible to name the PERFORMANCE MEMORY positions as well as the VOICE MEMORY positions. →P.40
- * When using the VOICE NAME function, the voice parameter buttons below the LED display become the character input buttons. In order to switch to a parameter called by one of these buttons, first exit the VOICE NAME mode by pressing the PERFORMANCE MEMORY/FUNCTION VOICE PARAMETER button, then select the desired parameter.

Fig. 54. Voice Name Display in Play Mode

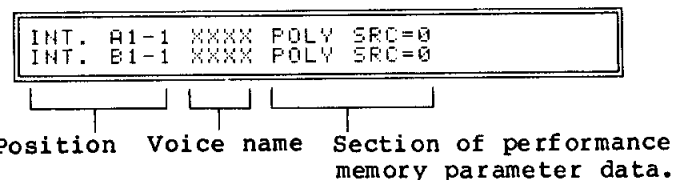

FUNCTION MODE/EFFECTS AND OTHER FUNCTIONS

In the FUNCTION mode, effect data which will be combined with the voice data for performance can be set. Memory functions and MIDI functions can also be set in this mode.

5-1 The 3 function of the FUNCTION mode

Most of the FUNCTION MODE parameters can be called using the PERFORMANCE MEMORY/FUNCTION switches. Further, most all parameters can be set independently for channel A and B. The parameters are divided into 3 main groups: PERFORMANCE MEMORY PARAMETERS, MEMORY MANAGEMENT and MIDI INFO CONTROL (fig. 55).

(1) PERFORMANCE MEMORY PARAMETER

This function permits setting effect or performance functions. The upper row of 8 switches in the PERFORMANCE MEMORY/FUNCTION section, the lower-row switches 1 through 3 (performance & voices), the KEY ASSIGN MODE switches, the CARTRIDGE switches and the VOICE MEMORY number switches can all be used in the PERFORMANCE MEMORY.

- * Both MASTER TUNE and DUAL MODE DETUNE functions are located in BANK 1. However, only DUAL MODE DETUNE can be stored in the PERFORMANCE MEMORY.
- * In BANK 2--8 the PITCH BEND, PORTAMENTO, LFO MODULATION and EG BIAS effect parameters, and the PROGRAM OUTPUT ASSIGN output parameters are available.
- * The KEY INDIVIDUAL AFTER TOUCH function has been included in the PERFORMANCE & VOICE buttons 1 through 3.

(2) MEMORY MANAGEMENT

These are the memory control functions. Buttons 4 --6 in the lower row of the PERFORMANCE MEMORY/FUNCTION group apply to memory management. The INITIALIZE MEMORY function for creating new voices from scratch, the EDIT RECALL BUFF function for retrieving lost edit data and other memory control functions are included. MEMORY MANAGEMENT functions cannot be stored in the PERFORMANCE MEMORY.

(3) MIDI INFO CONTROL

Controls the functions of the MIDI CONNECTOR. MIDI INFO CONTROL functions cannot be stored in the PERFORMANCE MEMORY.

5-2 The FUNCTION mode control process

(1) The FUNCTION mode control process

Of the FUNCTION mode functions, any process which involves the PERFORMANCE MEMORY PARAMETERS concerns the editing of effect or performance function data. The following processes, I through IV are possible. Other types of operation (MEMORY MANAGEMENT, MIDI INFO CONTROL, etc) fall under the heading of process V.

- * I: Editing internal PERFORMANCE MEMORY data.
Selection of the edit target/call the data to the buffer ⇒
Switch to the FUNCTION mode ⇒
Set data

Fig. 55. Function Mode Parameter Switches

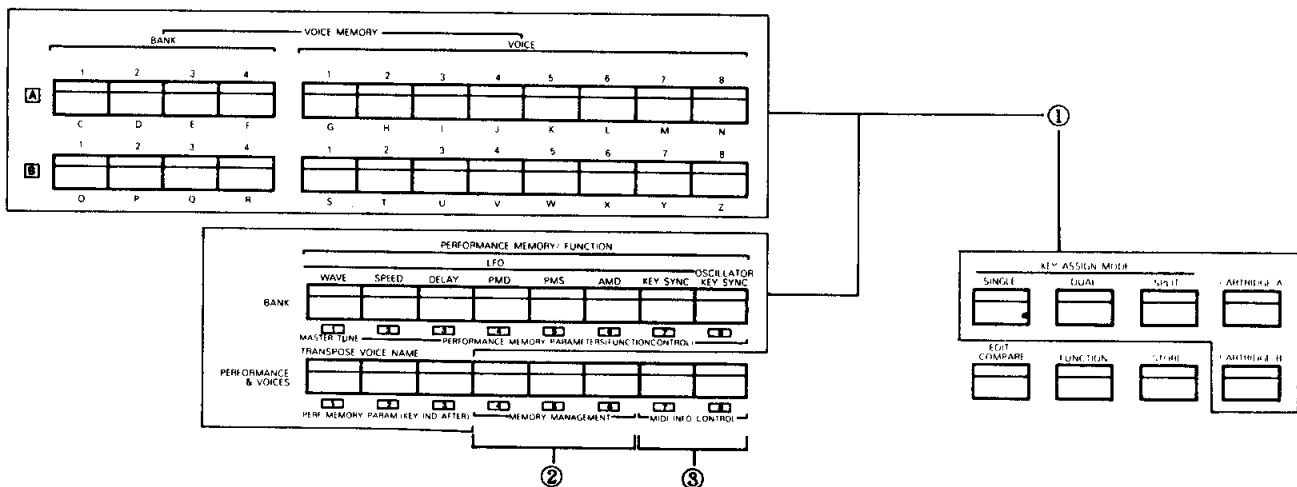

Store the FUNCTION data = replace the PERFORMANCE MEMORY

*I: Calling internal performance memory data (fig. 56)

*II: Editing PERFORMANCE MEMORY CARTRIDGE data.

Select the edit target/call the data to the buffer ⇒
 Switch to the FUNCTION mode ⇒
 Set data
 Store the FUNCTION data = replace the PERFORMANCE MEMORY

*III: Setting effects after voice editing or initialization.

Switch to the FUNCTION mode ⇒
 Set data ⇒
 Store the FUNCTION data = write to PERFORMANCE MEMORY

*IV: Combining data with a selected voice.

Select target voice/call to buffer ⇒
 Store the FUNCTION data = write to PERFORMANCE MEMORY

*V: MASTER TUNE, MEMORY MANAGEMENT or MIDI INFO. CONTROL operation.

Switch to FUNCTION mode ⇒
 Set data = control command

- (a) Turn all mode selectors OFF.
- * It does not matter if the EDIT switch is flashing.
- (b) When calling a VOICE CARTRIDGE memory number into the internal memory (e.g. when accessing ROM cartridge voices to use with one of the preset PERFORMANCE MEMORY positions) insert the appropriate voice memory cartridges in cartridge slot A and B.
- * In the case of a ROM cartridge, be sure to set the cartridge bank select switch to the desired bank before insertion.
- (c) Select the target PERFORMANCE MEMORY to be edited.
- * After selecting the PERFORMANCE MEMORY to be changed, switch to the FUNCTION mode.
- (d) To change the VOICE MEMORY number combination, select the new voice data which is to be combined.
- * Although the voice memory data numbers can be changed after editing the performance memory parameters, the effects and performance functions should be set according to the voice to be used. It is therefore better to call the voice data and edit the performance memory parameters to match the voice.

(2) TARGET DATA SELECTION/CALLING THE DATA TO THE BUFFER

To edit the performance memory or performance memory cartridge data, it is necessary to first call the data to be edited into the performance edit buffer. The method of calling performance memory cartridge data into the buffer is different from that of calling voice memory cartridge data into the buffer, so care should be taken to follow the correct procedure.

II: CALLING A PERFORMANCE MEMORY CARTRIDGE (fig. 57)

- (a) Turn all MODE selectors OFF.
- (b) Insert the PERFORMANCE MEMORY cartridge into cartridge slot A.
- * If the PERFORMANCE MEMORY cartridge is

Fig. 56. Calling Internal Performance Memory

Select voice memory positions which are to be combined.

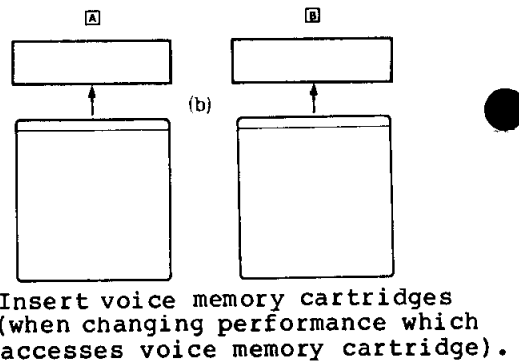
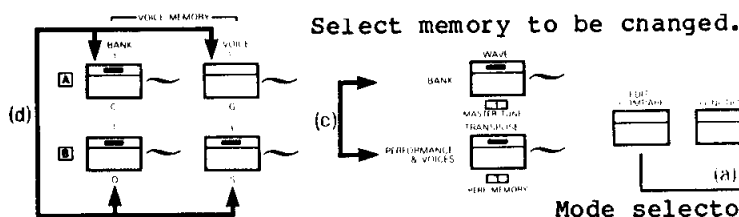
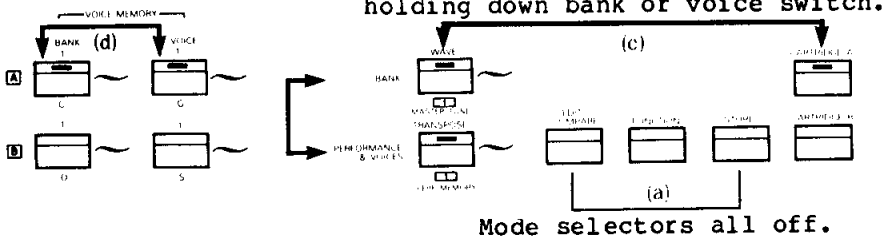

Fig. 57. Calling Cartridge Performance Memory

Select voice to which effects are to be added.



inserted into cartridge slot B the
 "***ERROR** Cartridge not ready!"
 message will be displayed when the
 following operation is performed.

- * When calling data from a RAM cartridge to be edited and returned to the same cartridge, make sure that the cartridge memory protect switch is OFF before inserting the cartridge.

(c) Hold a PERFORMANCE MEMORY bank switch or PERFORMANCE & VOICE switch down and press the CARTRIDGE switch.

- * If a PERFORMANCE MEMORY or PERFORMANCE & VOICE switch is not held, or it is released before pressing the CARTRIDGE switch, the "***ERROR** Cartridge format conflict!" message will be displayed. In this case return to step (c).

- * If a VOICE MEMORY CARTRIDGE is inserted the "***ERROR** Cartridge format conflict!" message will be displayed.

(d) Using the PERFORMANCE MEMORY or VOICE MEMORY buttons, select the target voice to which the effects will be applied.

- * VOICE MEMORY data can be called even in the FUNCTION mode. Edited effect data (PERFORMANCE MEMORY parameters) which have been combined with voice data can be stored in the PERFORMANCE MEMORY.

- * If the PERFORMANCE MEMORY bank 5--8 buttons are pressed the "***ERROR** Cartridge format conflict!" message will appear momentarily in the middle of the performance name display, or the "***ERROR** Cartridge not ready!"

message will be displayed in the channel B voice name display. In this case the effect data only will be called, and voice data will not be assigned (the voice memory data previously called into the buffer will be applied). This is because the cartridge and internal PERFORMANCE MEMORY data are the same. In banks 5--8, VOICE MEMORY CARTRIDGES will be assigned for both channels A AND B. In banks 5--8 it is also possible to disengage cartridge assignment, re-select an internal VOICE MEMORY and combine it with effects.

- * While using a PERFORMANCE MEMORY CARTRIDGE it is not possible to call data from a VOICE MEMORY CARTRIDGE in channel A.

** Continued in "SWITCHING TO THE FUNCTION MODE AND ENTERING DATA".

(3) SWITCHING TO THE FUNCTION MODE AND ENTERING DATA (fig. 58)

(e) Use the FUNCTION switch to switch to the FUNCTION mode. In this state the PERFORMANCE MEMORY/FUNCTION switches can be used to call the FUNCTION MODE FUNCTIONS.

(f) Respond to the process control prompts shown on the LCD display using the DATA ENTRY section.

- * In the FUNCTION mode just about all parameters can be applied independently to channels A and B. The channel will automatically be selected and indicated on the LCD display.

- * The LCD display will read "FUNCTION 1A

■■UUUU>>VVVV WWW (XX-YY) ZZ" (fig. 59).

- * "1" shows the position of the parameter (in this case, bank 1). "A" indicates the tone generator channel (in this case channel A).
- * "■■UUUU>>VVVV" are the parameter abbreviations. The double cursor (■■) shows the selected parameter.
- * "WWW" is a parameter or control prompt. "XX-YY" is the data range and "ZZ" is the data.
- * In most of the PERFORMANCE MEMORY/FUNCTION switches, a single switch will have four different functions (jobs). Each time the switch is pressed the next function is called. The "job" order for the switches is printed to the right of the control panel (fig. 60).
- * When the power is initially turned ON, the upper-row number 1 (MASTER TUNE) parameter is automatically selected (data set before the power was turned OFF is retained).
- (g) After performing the operation for one channel, switch to the other channel and repeat the operation. Channels can be switched by pressing a VOICE MEMORY bank or voice switch of the desired channel.

Fig. 58. Switching to Function Mode and Entering Data

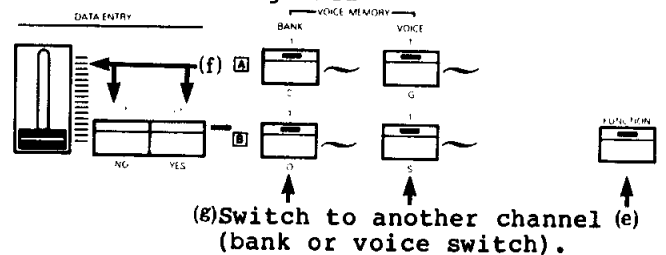

Fig. 59. Parameter position. Sound source channel. Short title or parameter.

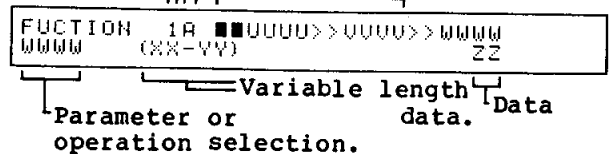

Fig. 60. Function Job Table

BANK	FUNCTION JOB TABLE											
	MASTER TUNE	PERFORMANCE MEMORY	PARAMETER	VOICE MEMORY	VOICE	FUNCTION	PERFORMANCE MEMORY	PARAMETER	VOICE MEMORY	VOICE	FUNCTION	PERFORMANCE MEMORY
JOB 1	MASTER TUNE	PERFORMANCE MEMORY	PARAMETER	VOICE MEMORY	VOICE	FUNCTION	PERFORMANCE MEMORY	PARAMETER	VOICE MEMORY	VOICE	FUNCTION	PERFORMANCE MEMORY
JOB 2	PERFORMANCE MEMORY	PARAMETER	VOICE MEMORY	VOICE	FUNCTION	PERFORMANCE MEMORY	PARAMETER	VOICE MEMORY	VOICE	FUNCTION	PERFORMANCE MEMORY	PARAMETER
JOB 3	PARAMETER	VOICE MEMORY	VOICE	FUNCTION	PERFORMANCE MEMORY	PARAMETER	VOICE MEMORY	VOICE	FUNCTION	PERFORMANCE MEMORY	PARAMETER	VOICE MEMORY
JOB 4	VOICE MEMORY	VOICE	FUNCTION	PERFORMANCE MEMORY	PARAMETER	VOICE MEMORY	VOICE	FUNCTION	PERFORMANCE MEMORY	PARAMETER	VOICE MEMORY	VOICE
JOB 5	VOICE	FUNCTION	PERFORMANCE MEMORY	PARAMETER	VOICE MEMORY	VOICE	FUNCTION	PERFORMANCE MEMORY	PARAMETER	VOICE MEMORY	VOICE	FUNCTION
JOB 6	FUNCTION	PERFORMANCE MEMORY	PARAMETER	VOICE MEMORY	VOICE	FUNCTION	PERFORMANCE MEMORY	PARAMETER	VOICE MEMORY	VOICE	FUNCTION	PERFORMANCE MEMORY
JOB 7	PERFORMANCE MEMORY	PARAMETER	VOICE MEMORY	VOICE	FUNCTION	PERFORMANCE MEMORY	PARAMETER	VOICE MEMORY	VOICE	FUNCTION	PERFORMANCE MEMORY	PARAMETER
JOB 8	PARAMETER	VOICE MEMORY	VOICE	FUNCTION	PERFORMANCE MEMORY	PARAMETER	VOICE MEMORY	VOICE	FUNCTION	PERFORMANCE MEMORY	PARAMETER	VOICE MEMORY
JOB 9	VOICE MEMORY	VOICE	FUNCTION	PERFORMANCE MEMORY	PARAMETER	VOICE MEMORY	VOICE	FUNCTION	PERFORMANCE MEMORY	PARAMETER	VOICE MEMORY	VOICE
JOB 10	VOICE	FUNCTION	PERFORMANCE MEMORY	PARAMETER	VOICE MEMORY	VOICE	FUNCTION	PERFORMANCE MEMORY	PARAMETER	VOICE MEMORY	VOICE	FUNCTION
JOB 11	FUNCTION	PERFORMANCE MEMORY	PARAMETER	VOICE MEMORY	VOICE	FUNCTION	PERFORMANCE MEMORY	PARAMETER	VOICE MEMORY	VOICE	FUNCTION	PERFORMANCE MEMORY
JOB 12	PERFORMANCE MEMORY	PARAMETER	VOICE MEMORY	VOICE	FUNCTION	PERFORMANCE MEMORY	PARAMETER	VOICE MEMORY	VOICE	FUNCTION	PERFORMANCE MEMORY	PARAMETER

(4) STORING FUNCTION DATA

Parameters set in the FUNCTION mode can be stored in the PERFORMANCE MEMORY. However, only PERFORMANCE MEMORY parameters can be stored. For this operation, four processes are possible according to the FUNCTION mode control processes I--IV. We'll describe

these in two groups. I and II are used when re-storing data back into the original memory position. III and IV are used when storing data into a new position.

- * When the power is initially turned ON, the internal memory protect system is automatically activated, preventing accidental erasure of the memory. The internal memory protect function must be turned OFF before a STORE operation.
- * When a STORE operation is performed, data originally in the STORE destination position is erased. If it is necessary to save such data, it should be stored in an external RAM cartridge. →P.45
- * Only a RAM cartridge that has been formatted for PERFORMANCE MEMORY (format=01) can be used. →P.45

I-II: RE-STORING DATA IN THE ORIGINAL MEMORY POSITION (fig. 61)

When editing PERFORMANCE MEMORY data and re-storing it in the original memory location, the STORE ALL function is used.

- (h) In order to turn OFF the memory protect function, press button 6 in the lower row (MEMORY MANAGEMENT) to call the memory protect write function.
- (i) The LCD display will read "Internal memory write protect ON". Press the DATA ENTRY section NO button to turn write protect OFF.
- * If STORE is attempted without turning

Fig. 61. Restoring Original Performance Memory

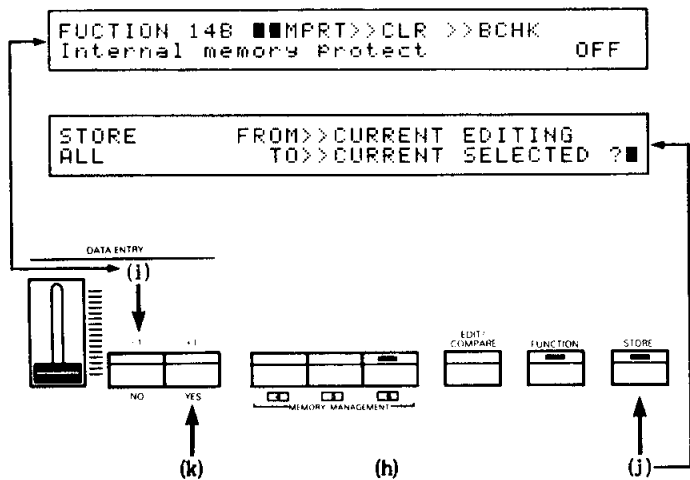
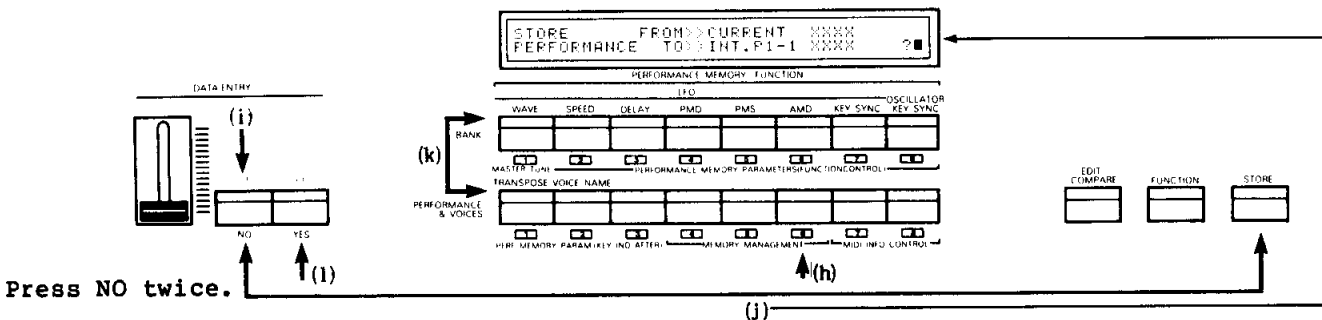

Fig. 62. Storing New Performance Memory



Press NO twice.

OFF protect memory write, the "***ERROR** W-protected" message will be displayed.

- (j) Switch to the STORE mode and the "STORE ALL FROM >> CURRENT EDITING TO >> CURRENT SELECTED" message will be displayed.
- * It is not possible to write data to a ROM cartridge. It is possible, however, to call data from a ROM cartridge into the buffer, and store it in the internal memory using the STORE PERFORMANCE function, or into a RAM cartridge. -III-IV
- * In the case of data called from a RAM PERFORMANCE CARTRIDGE to be edited, the STORE ALL function can be used to return the edited data to the same position in the RAM cartridge.
- (k) Press the DATA ENTRY YES button to begin the STORE operation.
- * When storing re-storing data within a RAM cartridge, be sure that the CARTRIDGE switch is ON before storing.

III-IV: STORING TO A NEW PERFORMANCE MEMORY LOCATION (fig. 62)

When storing to a new PERFORMANCE MEMORY position or when moving PERFORMANCE MEMORY data between the internal memory and a cartridge, use the STORE PERFORMANCE function.

- (h) Call PROTECT MEMORY WRITE.
- (i) Press the DATA ENTRY NO button to turn OFF the memory protect function. I(h)(i)
- (j) Switch to the STORE mode and press the DATA ENTRY NO button. This causes the "STORE PERFORMANCE FROM >> CURRENT XXXX TO >>INT P1-1 XXXX" message to be displayed, indicating that the STORE PERFORMANCE function has been called.
- * The STORE PERFORMANCE function works only with the PERFORMANCE MEMORY. →P.53
- * The "INT P1-1" portion of the display is the memory position, and "XXXX" is the performance name.
- * When combining PERFORMANCE MEMORY CARTRIDGE data with internal VOICE MEMORY data, and storing the combination in the internal PERFORMANCE MEMORY, first call the cartridge data into the PERFORMANCE EDIT BUFFER, then select the desired VOICE MEMORY number, and finally use the STORE PERFORMANCE function.
- * If the PERFORMANCE MEMORY 5--8 are selected with the performance memory in

the initial shipped condition (prior to any editing), PERFORMANCE MEMORY CARTRIDGE access is automatically selected when STORE PERFORMANCE is called.

(k) When a new memory position is selected using the PERFORMANCE MEMORY bank switches and PERFORMANCE & VOICE switches, the selected position is displayed following the "TO" portion of the LCD display.

- * When moving data from a cartridge to the internal memory, set the destination memory position after turning the CARTRIDGE switch OFF.
- * When moving data from the internal memory to a RAM cartridge, select the destination position when the CARTRIDGE switch is ON.

(l) Press the DATA ENTRY YES button to begin the store operation.

- * A RAM cartridge formatted for PERFORMANCE MEMORY (format=01) must be used. If a cartridge for VOICE MEMORY (format =00) the "***ERROR** R/W error!" message will be displayed, and the STORE operation will be terminated. →P.46

5-3 PERFORMANCE MEMORY PARAMETERS

Parameters which can be stored in the PERFORMANCE MEMORY include the FUNCTION CONTROL (PERFORMANCE MEMORY/FUNCTION section upper-row switches 2--8) parameters which affect all operators simultaneously, the KEY IND. AFTER (PERFORMANCE MEMORY/FUNCTION section lower-row switches 1--3) parameters which are independently programmable for each operator, KEY ASSIGN MODE, VOICE MEMORY and CARTRIDGE switches.

- * The PERFORMANCE MEMORY parameter data still resides in the PERFORMANCE EDIT BUFFER after the FUNCTION mode has been exited. If the PERFORMANCE MEMORY is called a second time, the previous data in the PERFORMANCE EDIT BUFFER is erased. If the data in the PERFORMANCE EDIT BUFFER should be saved, use the STORE FUNCTION (no function is available to recall data in the PERFORMANCE EDIT BUFFER.

MASTER TUNE (fig. 63)

(1) BANK 1 (F1)

All the tuning functions are provided here. This switch includes the MASTER TUNE and DUAL MODE DETUNE "jobs".

Job 1 - MASTER TUNE : -63 -- +63

This is the master tuning function. It affects both channels A and B simultaneously.

- * MASTER TUNE parameters can not be stored in the PERFORMANCE MEMORY.
- * The MASTER TUNE function is completely independent from all other functions, and affects all voices in the same way.

MASTER TUNE data remains as programmed until it is re-programmed using the FUNCTION mode.

- * Data range is from -63 to +63. When set at +00 A3 is the standard 440 Hz reference frequency. At -63 the overall keyboard pitch is lowered by -75 cents (3/4 semitone). At +63 the pitch is raised by 75 cents (3/4 semitone).
- * The LCD display will read "FUNCTION 1 ■■MTUN>>DTUN Master tuning XXX". "XXX" is the tuning data.
- * The MASTER TUNE function does not affect operators which are set to the FIXED FREQUENCY mode.

Job 2 - DUAL MODE DETUNE : 0--15

This function causes a difference in the pitch of channels A and B when the KEY ASSIGN MODE is set to DUAL. This results in a chorus-like effect. The DUAL MODE DETUNE function affects both channels A and B.

- * Data range is 0--15. At 0 the function is OFF, and at 15 the greatest amount of detune is achieved (at C3, the pitch difference is approximately 25 cents = 1/4 semitone).
- * When DUAL MODE DETUNE is used, the pitch of channel A is increased while the pitch of channel B is decreased correspondingly.
- * The LCD display will read "FUNCTION 1 MTUN■■DTUN Dual mode detuning (0--15) XX". "XX" is the data.
- * This function can be set independently of the EDIT mode OSCILLATOR DETUNE function.
- * This function will not work if the KEY ASSIGN MODE is set to SINGLE or SPLIT.
- * This function will not work with oscillators that are set to the FIXED FREQUENCY mode.

FUNCTION CONTROL (fig. 63)

(2) BANK 2 (F2)

This button has two jobs: POLY/MONO and SOURCE SELECT.

Job 1 - POLY/MONO

This sets the note output mode (polyphonic/monophonic).

Fig.63. Performance Memory Parameters

Master tune. Function control.

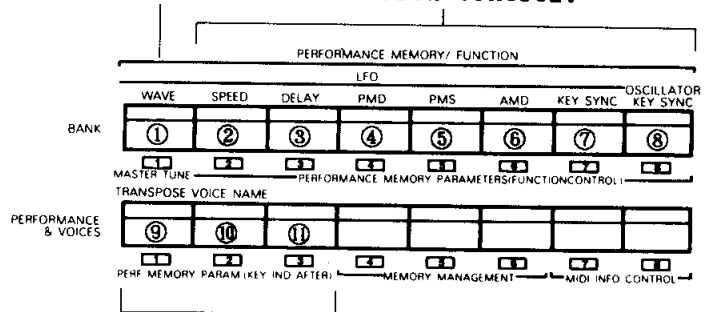

Key individual after.

- * When set to the POLY mode, polyphonic note output is possible (when the KEY ASSIGN MODE is set to SINGLE a maximum of 32 simultaneous output notes is possible. SPLIT = 16 + 16 simultaneous output notes. DUAL = 16 simultaneous output notes).
- * In the MONO mode the keyboard functions as a last-note-priority monophonic keyboard. If one key is held and a higher key is pressed, the higher note will take priority (will be output). In the same way, if a note is held and a lower key is pressed, the lower note will take priority.
- * The display will read "FUNCTION 2A ■■■PMOD>>SRC Polyphonic/Monophonic selector XXXX". "XXXX" is the POLY/MONO status.
- * The way in which portamento affects the POLY and MONO modes is different.
- * The POLY or MONO mode status of a voice can be checked in the PLAY mode voice name display.

Job 2 - SOURCE SELECT : 0--16

This function selects the DX1 FM tone generator control source. FM tone generator control can be derived not only from the DX1 keyboard, but via the rear-panel MIDI connector as well.

- * Data range is 0--16. When set to 0 the DX1 keyboard is selected. When set to 1--16 the corresponding MIDI receiving channel is selected (fig. 64). →P.67
- * If the (18) PERFORMANCE & VOICE button number 7 (OMNI MODE) is turned OFF, the DX1 keyboard will become inactive if SOURCE SELECT is set to 1--16. →P.48
- * The LCD display will read "FUNCTION 2A >>PHOD■■■SRC Source Select (0=int KBD, 1--16=MIDI) XX" "XX" is the selected channel.
- * In the PLAY mode voice name display the SOURCE SELECT data is shown as "SRC=XX".

(3) BANK 3 (F3)

This incorporates the 2 PITCH BEND related jobs: PITCH BEND RANGE and PITCH BEND STEP.

Job 1 - PITCH BEND RANGE : 0--12

Controls the amount of pitch variation introduced by the PITCH BEND WHEEL (fig. 81).

Fig. 64. Source Select

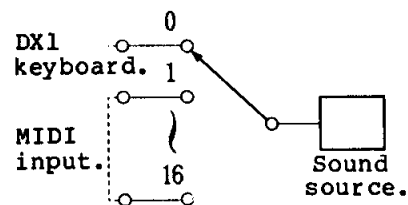

Fig. 65. Pitch Bend Wheel



- * Data range is 0--12. 0=OFF. Each increment corresponds to a semitone of pitch variation. At 12 a ± 1 octave (± 1200 cent) variation is possible.
- * The LCD display will read "FUNCTION 3A ■■■PBR>>PBS Pitch bend range (0--12 semitone) XX". "XX" is the data.
- * PITCH BEND RANGE will not function if PITCH BEND STEP is set from 1--12. In this case the range is set at ± 1 octave.

Job 2 - PITCH BEND STEP : 0--12

Rather than a continuous pitch bend effect, this creates a step-wise pitch bend effect.

- * The pitch bend range in the step bend mode is fixed at 1 octave.
- * Data range is 0--12. 0= normal pitch bend mode. Each increment (1--12) increases the step interval by 100 cents (1 semitone). At 12 a single 1-octave step is produced.
- * The LCD display will read "FUNCTION 3A >>PBR■■■PBS Pitch bend step (0--12 semitone) XX" "XX" is the data.

(4) BANK 4 (F4)

This includes the 4 PORTAMENTO related functions--PORTAMENTO/GLISSANDO, PORTAMENTO MODE, PEDAL ASSIGN, PORTAMENTO TIME.

Job 1 - PORTAMENTO/GLISSANDO : PORT/GLIS

Sets the PORTAMENTO (continuous pitch variation) or GLISSANDO (step-wise pitch variation) mode. This is a master control for the PORTAMENTO TIME and PORTAMENTO SLIDER controls.

- * The LCD display will read "FUNCTION 4A ■■■GLIS>>PORM>>PASN>>PTIM Portamento/Glissando (PORT/GLIS) XXXX". "XXXX" is the PORT/GLIS status.

Job 2 - PORTAMENTO MODE

This is the master PORTAMENTO select function. Both the PORTAMENTO TIME and PORTAMENTO SLIDER controlled effects are switched simultaneously. However, the effect will also be switched by the bank 2 POLY/MONO selector. In the POLY mode functions (1) and (2) below are available, and in the MONO mode functions (3) and (4) are available.

- * In the POLY Mode

(1) SUSTAIN PITCH RETAIN

Sustain permits holding the pitch of pressed keys up to the maximum number of DX1 output notes AL = 16, SPLIT = 16+16, SINGLE =32). For example, one note can be held in sustain while a subsequent note is played with the portamento effect.

(2) SUSTAIN PITCH FOLLOW

All notes played portamento to a subsequently played note.

- * In the MONO Mode

(3) FINGERED PORTAMENTO

Portamento only occurs if a key is held while a subsequent key is played (legato form). This is useful for recreating the effect of guitar hammer-on and pull-off techniques, or wood bass glissando effects.

(4) FULL TIME PORTAMENTO

A "conventional" monophonic portamento effect.

- * The LCD display will read "FUNCTION 4A >>GLIS■■■PORM■■■PASN■■■PTIM Portamento moue XXXXXX" "XXXXXX" is the selected effect.

Job 3 - PEDAL ASSIGN : ON/OFF

Turns portamento control via the PORTAMENTO SLIDER at the left side of the DX1 panel, and the rear-panel FOOT SW ON or OFF.

- * When ON the PORTAMENTO SLIDER can be used to set portamento time, and the portamento effect can be turned on or off using the foot switch connected to the FOOT SW jack (FC-4 or FC-5 foot switch).
- * When OFF, neither the PORTAMENTO SLIDER or rear-panel FOOT SW will function.
- * The portamento effect is programmed when the PORTAMENTO TIME function, below, is set, regardless of the PEDAL ASSIGN state.
- * The LCD display will read "FUNCTION 4A >>GLIS>>PORM■■■PASN■■■PTIM Portamento pedal & knob assign XXX" "XXX" indicates the ON/OFF state.

Job 4 - PORTAMENTO TIME : 0--99

Sets the portamento or glissando speed. This permits the portamento effect to be set regardless of the PORTAMENTO SLIDER and FOOT SW.

- * Data range is 0--99. 0=OFF. At 99 the slowest (longest) portamento is produced (approximately 19 seconds from C1 to C6).
- * When PEDAL ASSIGN is ON, data can be entered using the PORTAMENTO SLIDER as well as the DATA ENTRY section.
- * The LCD display will read "FUNCTION 4A >>GLIS>>PORM■■■PASN■■■PTIM Portamento time (0-99) XX" "XX" is the data.

(5) BANK 5 (F5)

This includes the 3 connector related functions--OUTPUT LEVEL ATTENUATE, PROG. OUT ASSIGN, and SUSTAIN PEDAL ASSIGN.

Job 1 - OUTPUT LEVEL ATTENUATE : 0--7

This is the output level attenuator which permits adjusting the level of the DX1 output signal. This is particularly useful for compensating for individual voice level variations caused by the KEY VELOCITY SENSITIVITY, AFTER TOUCH, and KEY INDIV. AFTER TOUCH settings.

- * The data range is 0--7. 7 is the normal setting (100%). At 0 output is OFF (0%) and no sound will be output. The amount of attenuation for each

setting is given in the following chart:

DATA	0	1	2	3	4	5	6	7
LEVEL	0%	2%	4%	8%	15%	30%	54%	100%

The LCD display will read "FUNCTION 5A ■■■ATN>>PRGO>>SUSP Audio output level attenuator (0-7) X". "X" is the data.

Job 2 - PROG. OUT ASSIGN : ON/OFF

Turns the PROGRAM OUTPUT (mono mix of channels A and B) ON or OFF.

- * The output signal consists of channels A + B only when both channels are ON.
- * The unbalanced phone jack and balanced XLR connector are turned ON/OFF simultaneously.
- * The A and B output connectors are ON at all times, regardless of the state of the PROG. OUT ASSIGN data.
- * The LCD display will read "FUNCTION 5A >>ATN■■■PRGO>>SUSP Program output assign XXX". "XXX" is the ON/OFF status.

Job 3 - SUSTAIN PEDAL ASSIGN : ON/OFF

This turns the sustain footswitch connected to the SUSTAIN terminal ON or OFF.

- * When ON, the sustain effect can be controlled via a footswitch (FC-4 or FC-5) connected to the rear-panel SUSTAIN connector. When OFF the SUSTAIN foot switch will not function.
- * The LCD display will read "FUNCTION 5A >>ATN>>PRGO■■■SUSP Sustain pedal assign XXX". "XXX" is the ON/OFF status.
- * The sustain effect is equivalent to the key-on state, producing a sustain level according to the setting of the EG. When L3 is set at 1 or higher, for example, the L3 level is held after it is reached via R3. If L3 is set to 0, the sustain sound consists of a decay at R3. No sustain will be produced if L3=0 and R3=99. -P.25

(6) BANK 6 (F6)

This determines the operation of the MODULATION WHEEL and FOOT CONTROLLER, and incorporates the 4 jobs--MOD. WHEEL SENSITIVITY, MOD. WHEEL ASSIGN, FOOT CONT. SENSITIVITY, and FOOT CONT. ASSIGN.

- * In the DX1, the MODULATION WHEEL and FOOT CONTROLLER can be used to apply vibrato (pitch modulation), tremolo (carrier amplitude modulation), wow (modulator amplitude modulation) effects using LFO modulation, and brilliance (modulator EG BIAS) or volume (carrier EG BIAS) control (fig. 66).
- * The MODULATION WHEEL is located to the left of the keyboard. The least modulation is applied (0) with the wheel fully toward the operator, and the greatest modulation depth is achieved with the wheel rolled fully away from the operator.
- * The foot controller (FC-3A) is

Fig. 66. LFO Modulation Control Function

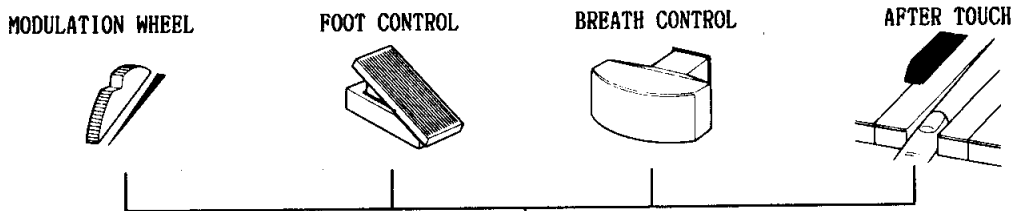

Each of the four controllers can regulate effects such as tremolo, vibrato, wow, etc. Also, data setting can be carried out separately by all four controllers.

connected to the rear-panel MODULATION connector.

- * Pressing the pedal down increases the depth of the effect.

Job 1 - MOD. WHEEL SENSITIVITY : 0--15

Sets the depth of the effect applied with the MODULATION WHEEL.

- * The data range is 0--15. At 0 the MODULATION WHEEL is OFF. At 15 maximum effect variation is achieved.
- * The LCD display will read "FUNCTION 6A ■■MWS>>MWA>>FCS>>FCA Modulation wheel sensitivity (0-15) XX". "XX" is the data.
- * If the EDIT mode AMPL. MODULATION SENSITIVITY master parameter is set to 0 for all operators, AMPLITUDE MODULATION (tremolo, wow) and EG BIAS (brilliance, expression) will not function. Also if the EDIT mode PITCH MODULATION SENS. master parameter is set to 0, PITCH MODULATION (vibrato) will not function. →P.27

Job 2 - MOD. WHEEL ASSIGN : EBC. AMD. PMD

Selects the effect to be controlled by the MODULATION WHEEL. PITCH MODULATION, AMPLITUDE MODULATION or EG BIAS can be selected.

- * The selected function is indicated by a 3-digit display (0=OFF, 1=ON). From the left digit to the right: EBC (EG BIAS CONTROL), AMD (AMPLITUDE MODULATION DEPTH), PMD (PITCH MODULATION DEPTH). For example "001" indicates that EBC and AMD are OFF, while PMD is ON.
- * When EBC is ON and AMPL. MODULATION SENSITIVITY is greater than 1, applied to a modulator the result is brilliance control, and applied to a carrier the result is volume (expression) control.
- * When PMD is ON and PITCH MODULATION SENS. is greater than 1, vibrato control is possible.
- * When AMD is ON and AMPL. MODULATION is greater than 1, applied to a carrier the result is tremolo control, and applied to a modulator the result is wow control.
- * More than one effect can be selected at a time. Pressing the DATA ENTRY YES button consecutively results in the following selection sequence: 000 ⇒ 001 ⇒ 010 ⇒ 011 ⇒ 100 ⇒ 101 ⇒ 110 ⇒ 111. Pressing the DATA ENTRY NO button

reverses this sequence.

- * The LCD display will read "FUNCTION 6A >>MWS■■MWA>>FCS>>FCA Mod. wheel assign (EBC.AMD.PMD) XXX". "XXX" is the effect selection data as described above.

Job 3 - FOOT CONT. SENSITIVITY : 0--15

Sets the depth of the effect applied with the FOOT CONTROLLER.

- * The data range is 0--15. At 0 the FOOT CONTROLLER is OFF. At 15 maximum effect variation is achieved.
- * The LCD display will read "FUNCTION 6A >>MWS>>MWA■■FCS>>FCA Foot controller sensitivity (0-15) XX". "XX" is the data.
- * If the EDIT mode AMPL. MODULATION SENSITIVITY master parameter is set to 0 for all operators, AMPLITUDE MODULATION (tremolo, wow) and EG BIAS (brilliance, expression) will not function. Also if the EDIT mode PITCH MODULATION SENS. master parameter is set to 0, PITCH MODULATION (vibrato) will not function.

Job 4 - FOOT CONT. ASSIGN : EBC. AMD. PMD

Selects the effect to be controlled by the FOOT CONTROLLER. PITCH MODULATION, AMPLITUDE MODULATION or EG BIAS can be selected.

- * The selected function is indicated by a 3-digit display (0=OFF, 1=ON). From the left digit to the right: EBC (EG BIAS CONTROL), AMD (AMPLITUDE MODULATION DEPTH), PMD (PITCH MODULATION DEPTH).
- * The EBC, AMD and PMD effects are the same as Job 2 - MOD. WHEEL ASSIGN.
- * More than one effect can be selected at a time. Pressing the DATA ENTRY YES button consecutively results in the following selection sequence: 000->001->010->011->100->101->110->111. Pressing the DATA ENTRY NO button reverses this sequence.
- * The LCD display will read "FUNCTION 6A >>MWS>>MWA>>FCS■■FCA Foot control assign (EBC.AMD.PMD) XXX". "XXX" is the effect selection data as described above.
- * If a foot controller is not connected and the EDIT mode AMPL. MODULATION SENSITIVITY parameter is set to 3 for all carriers, and the FOOT CONT. ASSIGN EBC is ON, and FOOT CONT. SENSITIVITY is set to 15, no sound will be output.

This because in the above state the foot controller is set up to be a volume control, and must be pressed to produce sound output.

(7) BANK 7 (F7)

This determines the operation of the BREATH CONTROLLER and AFTER TOUCH, and incorporates the 4 jobs--BRTH CONT. SENSITIVITY, BRTH CONT. ASSIGN, AFTER TOUCH SENSITIVITY, and AFTER TOUCH ASSIGN.

- * In the DX1, the BREATH CONTROLLER and AFTER TOUCH can be used to apply vibrato (pitch modulation), tremolo (carrier amplitude modulation), wow (modulator amplitude modulation) effects using LFO modulation, and brilliance (modulator EG BIAS) or volume (carrier EG BIAS) control (fig. 66).
- * The ECL BREATH CONTROLLER is a mouthpiece type device which controls the appropriate effect according to the air pressure (breath pressure) applied to it.
- * AFTER TOUCH permits controlling the depth of the programmed effect according to the pressure applied to the keys after initial key attack..

Job 1 - BRTH CONT. SENSITIVITY : 0--15

Sets the depth of the effect applied with the BREATH CONTROLLER.

- * The data range is 0--15. At 0 the BREATH CONTROLLER is OFF. At 15 maximum effect variation is achieved.
- * The LCD display will read "FUNCTION 7A ■■BCS>>BCA>>AFS>>AFA Breath controlr sensitivity (0-15) XX". "XX" is the data.
- * If the EDIT mode AMPL. MODULATION SENSITIVITY master parameter is set to 0 for all operators, AMPLITUDE MODULATION (tremolo, wow) and EG BIAS (brilliance, expression) will not function. Also if the EDIT mode PITCH MODULATION SENS. master parameter is set to 0, PITCH MODULATION (vibrato) will not function. -P.27

Job 2 - BRTH CONT. ASSIGN : EBC. AMD. PMD

Selects the effect to be controlled by the BREATH CONTROLLER. PITCH MODULATION, AMPLITUDE MODULATION or EG BIAS can be selected.

- * The selected function is indicated by a 3-digit display (0=OFF, 1=ON). From the left digit to the right: EBC (EG BIAS CONTROL), AMD (AMPLITUDE MODULATION DEPTH), PMD (PITCH MODULATION DEPTH). For example "001" indicates that EBC and AMD are OFF, while PMD is ON.
- * The EBC, AMD and PMD effects are the same as BANK 6 Job 2 - MOD. WHEEL ASSIGN. -P.38
- * More than one effect can be selected at a time. Pressing the DATA ENTRY YES button consecutively results in the following selection sequence: 000->001->010->011->100->101->110->111.

Pressing the DATA ENTRY NO button reverses this sequence.

- * The LCD display will read "FUNCTION 7A >>BCS■■BCA>>AFS>>AFA Breath controller assign (EBC.PMD.AMD) XXX". "XXX" is the effect selection data as described above.
- * If a BREATH CONTROLLER is not connected and the EDIT mode AMPL. MODULATION SENSITIVITY parameter is set to 3 for all carriers, the BRTH CONT. ASSIGN EBC is ON, and BRTH CONT. SENSITIVITY is set to 15, no sound will be output. This is because in the above state, the BREATH CONTROLLER is set up as a volume control, and must be blown into to produce sound.

Job 3 - AFTER TOUCH SENSITIVITY : 0--15

Sets the depth of the effect applied with AFTER TOUCH.

- * The data range is 0--15. At 0 AFTER TOUCH is OFF. At 15 maximum effect variation is achieved.
- * The LCD display will read "FUNCTION 7A >>BCS>>BCA■■AFS>>AFA After touch sensitivity (0-15) XX". "XX" is the data.
- * If the EDIT mode AMPL. MODULATION SENSITIVITY master parameter is set to 0 for all operators, AMPLITUDE MODULATION (tremolo, wow) and EG BIAS (brilliance, expression) will not function. Also if the EDIT mode PITCH MODULATION SENS. master parameter is set to 0, PITCH MODULATION (vibrato) will not function.

Job 4 - AFTER TOUCH ASSIGN : EBC. AMD. PMD

Selects the effect to be controlled by AFTER TOUCH. PITCH MODULATION, AMPLITUDE MODULATION or EG BIAS can be selected.

- * The selected function is indicated by a 3-digit display (0=OFF, 1=ON). From the left digit to the right: EBC (EG BIAS CONTROL), AMD (AMPLITUDE MODULATION DEPTH), PMD (PITCH MODULATION DEPTH).
- * The EBC, AMD and PMD effects are the same as BANK 6 Job 2 - MOD. WHEEL ASSIGN. -P.38
- * More than one effect can be selected at a time. Pressing the DATA ENTRY YES button consecutively results in the following selection sequence: 000->001->010->011->100->101->110->111. Pressing the DATA ENTRY NO button reverses this sequence.
- * The LCD display will read "FUNCTION 7A >>BCS>>BCA>>AFS■■AFA After touch assign (EBC.PMD.AMD) XXX". "XXX" is the effect selection data as described above.

(8) BANK 8 (F8)

This includes 3 jobs: the SPLIT POINT function used to determine at which key the keyboard will be split into channel A and channel B sections, the KEY SHIFT function which shifts the range of the keyboard, and the PERFORMANCE NAME function for naming PERFORMANCE MEMORY positions.

Job 1 - SPLIT POINT : A-1 -- A7

The DX1 permits assigning the channel A and channel B tone generators to different sections of the keyboard (KEY ASSIGN MODE = SPLIT). The SPLIT POINT function determines the key at which the keyboard is split between the two channels.

- * Channel A is assigned to the keyboard section below (to the left of) the split point, and channel B is assigned to the keyboard section above the split point.
- * This will have no effect if the KEY ASSIGN MODE is set to DUAL or SINGLE.
- * If a split point is not programmed, C3 is set as the default split point.
- * The SPLIT POINT can be set by pressing the appropriate key, the key name is displayed on the LCD display. The data range is E0--E6.
- * When using the DATA ENTRY section to input data, the data range is A-1 -- A7.
- * SPLIT POINT data can not be altered using the keyboard. If the wrong key is pressed, the data must be altered using the DATA ENTRY section, or the SPLIT POINT function must be re-entered.
- * If the DATA ENTRY section is used first, the keyboard can not be used to enter different data.
- * The SPLIT POINT key name display is based on the reference keyboard pitch. If the KEY SHIFT (below) or EDIT mode KEY TRANSPOSE function is used to alter the overall keyboard pitch, the key name display will not correspond to the actual keyboard pitch.
- * The display will read "FUNCTION 8A ■■■SPNT>>PKS>>PNAM Split point (split board only ZX!!". "XX" is the data.

Job 2 - KEY SHIFT : +24 -- -24

This functions in exactly the same way as the EDIT mode KEY TRANSPOSE function. It permits transposing the overall pitch of the keyboard. All operators are affected simultaneously.

- * The data range is +24 to -24. Each increment corresponds to a semitone step. With C3 as the reference pitch, this provides a ± 2 octave transposition range.
- * Normally this is set to +00 (reference pitch).
- * Data can be set simply by pressing a key on the keyboard. The key which is pressed takes on the reference pitch (C3), and the rest of the keyboard is transposed accordingly. -P.29
- * Pressing any key higher than C5 results in a +24 data setting, and pressing any key lower than C1 results in a -24 data setting.
- * Data can also be entered using the DATA ENTRY section.
- * KEY SHIFT data can not be altered using the keyboard. If the wrong key is pressed, the data must be altered using the DATA ENTRY section, or the KEY SHIFT function must be re-entered.

- * If the DATA ENTRY section is used first, the keyboard can not be used to enter different data.
- * The LCD display will read "FUNCTION 8A >>SPNT■■■PKS>>PNAM Performance key shift XX". "XX" is the data.

Job 3 - PERFORMANCE NAME : 30 characters

This function permits giving data in the PERFORMANCE MEMORY a name of up to 30 characters in length.

- * The LCD will read "FUNCTION 8A >>SPNT>>PKS■■■PNAM **■XXXXXXXXXX***". The "■XXXXXXXXXX" portion of the display is the performance name. Characters are entered one at a time using the cursor (■).
- * Characters which can be used for naming voices are printed below the VOICE PARAMETER and VOICE MEMORY buttons. Pressing a button inputs the corresponding character which is then displayed at the appropriate position on the LCD display.
- * The cursor can be moved using the DATA ENTRY section + and - buttons (fig. 67).
- * In the PLAY mode, the performance name is displayed on the lower row of the LCD display.
- * When using the PERFORMANCE NAME function, the VOICE MEMORY buttons become the character input buttons, so a different VOICE MEMORY position can not be selected.

Fig. 67. Examples of Characters and Symbols Used for Naming

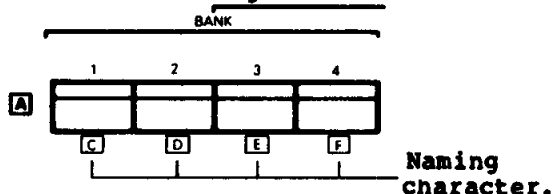

Fig. 68. Performance Name Display in Play Mode



KEY IND. AFTER (fig. 63)

This KEY INDIVIDUAL AFTER TOUCH function permits individually setting the pressure response of each key on the keyboard to control operator output level for volume or brilliance variation. Unlike the (7) AFTER TOUCH function, KEY IND. AFTER sets the response of each key individually permitting exceptionally fine expressive control.

- * The depth can be set independently for each operator.
- * KEY IND. AFTER data is completely independent from and unaffected by (7) AFTER TOUCH data.
- * Operator level is controlled by pressure-sensitive electronic elements incorporated in each key. Greater key pressure produces a higher output level. The effect is the same AFTER TOUCH EBC (EG BIAS CONTROL).

* Generally, the highest output level available with KEY IND. AFTER response is equal to the OPERATOR OUTPUT LEVEL setting. However, when TOTAL SENSITIVITY described in (9) below and the OPERATOR DEPTH parameters described in (10) and (11) below are all set to 15 and AFTER TOUCH SENSITIVITY is set to 0, peak output level can exceed the OPERATOR OUTPUT LEVEL setting by a maximum of 6 dB.

(9) PERFORMANCE & VOICE 1 (F9)

This button incorporates the KEY INDIVIDUAL AFTER TOUCH parameters: TOTAL SENSITIVITY, DECAY RATE and RELEASE RATE.

Job 1 - TOTAL SENSITIVITY : 0--15

Sets the overall sensitivity of the KEY IND. AFTER function. All operators are affected simultaneously.

- * The data range is 0--15. At 0 KEY IND. AFTER TOUCH is OFF, and at 15 maximum level variation is achieved.
- * This will not function if the OPERATOR DEPTH parameters described in (10) and (11), below, are all 0.
- * The LCD display will read "FUNCTION 9A ■■KTS>>KDR>>KRR Key indiv. A.T. sensitivity (0-15) XX". "XX" is the data.

Job 2 - DECAY RATE : 0--99

Sets the rate at which the output level decays after pressure is released from a key to which KEY INDIVIDUAL AFTER TOUCH is applied (the key is still held).

- * The data range is 0--99. 0 sets the slowest decay, and 99 results in an immediate drop in level when key pressure is released (fig. 69).
- * Setting a relatively long decay rate prevents level variation due to uneven key pressure while playing long tones, for a more stable effect.
- * Setting a fast decay rate permits touch response effects to be used even in fast passages.
- * The LCD display reads "FUNCTION 9A >>KTS■■KDR>>KRR Key indiv. A.T. decay rate (0-99) XX". "XX" is the data.

Job 3 - RELEASE RATE : 0--99

Determines the rate at which output level decays after a key is released.

- * The data range is 0--99. 0 sets the slowest decay, and 99 results in an immediate drop in level when a key is released (fig. 70).

Fig. 69. Decay Rate

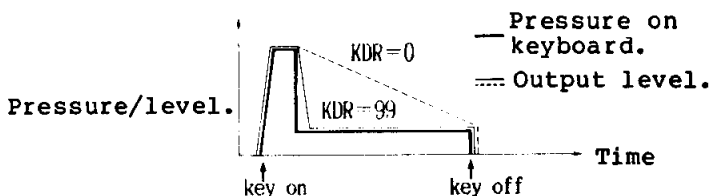

- * Longer RELEASE RATE settings result in sustain-like effects without using the SUSTAIN footswitch or setting a long EG R4 value.
- * The LCD display will read "FUNCTION 9A >>KTS>>KDR■■KRR Key indiv. A.T. release rate (0-99) XX". "XX" is the data.

(10) PERFORMANCE & VOICE 2 (F10)

Sets the depth of the KEY INDIVIDUAL AFTER TOUCH effect for each operator. Applied to a carrier the result is a level variation, and applied to a modulator the result is a timbre variation. 3 jobs are included: OP 1 DEPTH, OP 2 DEPTH and OP 3 DEPTH.

Job 1 - OP 1 depth : 0--15

Sets the depth of KEY INDIVIDUAL AFTER TOUCH for operator 1.

- * The data range is 0--15. 0=OFF, and 15 results in maximum variation according to the setting of TOTAL SENSITIVITY. Also, at 15 the DECAY RATE and RELEASE RATE effects are the strongest.
- * This will not function when TOTAL SENSITIVITY is set to 0.
- * The LCD display will read "FUNCTION 10A ■■KOP1>>KOP2>>KOP3 Key indiv. A.T. OP1 depth (0-15) XX". "XX" is the data.

Job 2 - OP 2 DEPTH : 0--15

Sets the operator 2 depth. Functions the same as OP 1 DEPTH above.

Job 3 - OP 3 DEPTH : 0--15

Sets the operator 3 depth. Functions the same as OP 1 DEPTH above.

(11) PERFORMANCE & VOICE 3 (F11)

Sets the depth of the KEY INDIVIDUAL AFTER TOUCH effect for each operator. 3 jobs are included: OP 4 DEPTH, OP 5 DEPTH and OP 6 DEPTH.

Job 1 - OP 4 DEPTH : 0--15

Sets the operator 4 depth. Functions the same as OP 1 DEPTH above.

Job 2 - OP 5 DEPTH : 0--15

Sets the operator 5 depth. Functions the same as OP 1 DEPTH above.

Job 3 - OP 6 DEPTH : 0--15

Sets the operator 6 depth. Functions the same as OP 1 DEPTH above.

Fig. 70. Release Rate

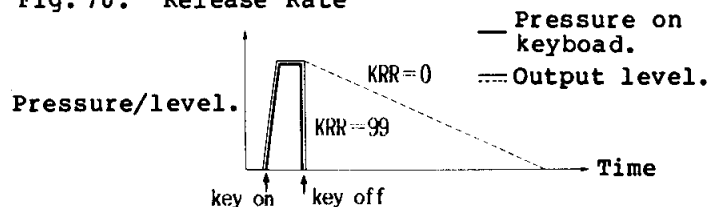

(12) VOICE MEMORY (fig. 71)

It is possible to store VOICE MEMORY data in a PERFORMANCE MEMORY location. In this way, the combination of voice data and performance parameters creates a "total" sound for performance.

Fig. 71. Voice Memory

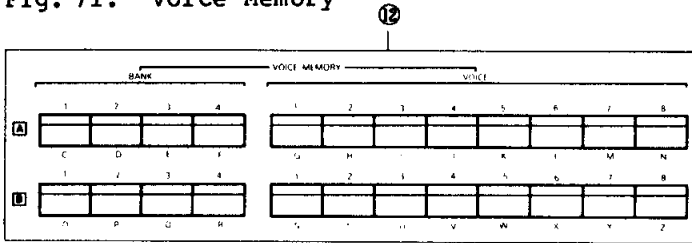

(13) CARTRIDGE SW (fig. 72)

When a cartridge voice is selected, and when the cartridge voice data is stored in a PERFORMANCE MEMORY, the ON/OFF status of the CARTRIDGE switch is also memorized.

(14) KEY ASSIGN MODE : SINGLE/DUAL/SPLIT (fig. 72)

The SINGE, DUAL or SPLIT KEY ASSIGN MODE can be selected, combined with VOICE MEMORY data and stored in the PERFORMANCE MEMORY.

- * The SPLIT POINT for the SPLIT mode is set using the SPLIT POINT function described in (8) Job 1. →P.40

Fig. 72. Cartridge and Key Assign Mode Switches

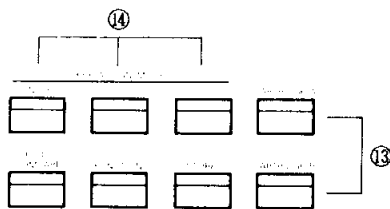

5-4 MEMORY MANEGEMENT

Most of the DX1 functions which deal with the memory -- MEMORY MANAGEMENT -- are accessible via the PERFORMANCE MEMORY/FUNCTION buttons 4--6 on the lower row. The MEMORY MANAGEMENT functions are for memory control only, and can not be memorized.

Fig. 73. Memory Management

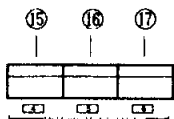

(15) PERFORMANCE & VOICE 4 (F12)

This includes the memory management functions relating to the voice parameters. 4 Jobs are included: COPY OP DATA, SAVE

TEMP. OPERATOR, INITIALIZE MEMORY, and RECALL EDIT BUFF.

Job 1 - COPY OP DATA

This function permits copying the data for one operator in a voice to another operator (fig. 74). It is designed to shorten and simplify the voice creation process. COPY OP DATA incorporates 2 Sub-Jobs: COPY ENVELOPE DATA and COPY OSCILLATOR DATA.

- * This function can not be used to copy data from one voice to another, or to a different channel.
- * COPY ENVELOPE DATA and COPY OSCILLATOR DATA are called alternately by pressing the DATA ENTRY NO button.

*COPY ENVELOPE DATA (Sub-Job 1)

The 8 EG parameters (R1--R4/L1--L4) and 6 KEYBOARD SCALING parameters (LEVEL SCALING, L--R DEPTH, L--R CURVE, BREAK POINT, RATE SCALING DEPTH) are all copied.

- * The LCD display will read "FUNCTION 12A ■■COPY>>TEMP>>INIT>>RCAL Copy envelope data From OPl to OPl OK?".

*COPY OSCILLATOR DATA (Sub-Job 2)

The 4 OSCILLATOR parameters (MODE, DETUNE, COARES, FINE) are all copied.

- * The LCD display will read "FUNCTION 12A ■■COPY>>TEMP>>INIT>>RCAL Copy oscillator From OPl to OPl OK?".

**The COPY OP DATA process

- Call any function other than COPY OP DATA in the FUNCTION mode.
 - Use OPERATOR SELECT to select the operator from which you wish to copy the data.
 - Select the "■■COPY" display using the PERFORMANCE & VOICE switch 4.
 - COPY ENVELOPE DATA is automatically called. To use COPY OSCILLATOR DATA press the DATA ENTRY NO button.
 - At this point both the "From" and "to" portions of the display will point to the originally selected operator.
 - Select the operator to which the data is to be copied using the OPERATOR SELECT buttons.
 - The selected destination operator will be shown on the display.
 - Press the DATA ENTRY YES button to copy the data.
 - The "From OPX" portion of the display now indicates the selected destination operator, and the data is shown on the LED display panel. It is possible to continue copying the same data to other operators in this way.
- * To change the origin operator, return to step (a).

Job 2 - SAVE TEMP. OPERATOR

This function makes it possible to copy operator data from one voice to another, or to a different channel via a special

"temporary" memory (fig. 75). 2 Jobs are incorporated: TEMPORARY SAVE OP DATA and EXTRACT TEMPORARY OP DATA.

- * All individual operator parameters available in the EDIT mode can be copied.
- * It is also possible to copy data from one operator to another within the same voice.
- * The origin and destination operators are not displayed.
- * TEMPORARY SAVE OP DATA and EXTRACT TEMPORARY OP DATA can be called alternately by pressing the DATA ENTRY NO button.

***TEMPORARY SAVE OP DATA (Sub-Job 1)**

Stores the selected operator data in a temporary memory (different from the BUFFER). Data stored in the temporary memory is retained until the TEMPORARY SAVE OP DATA function is performed again.

- * The LCD display will read "FUNCTION 12A
 ■■■>>COPY TEMP>>INIT>>RCAL SUBJOB 1
 :Temporary save OP data ?".

***EXTRACT TEMPORARY OP DATA (Sub-Job 2)**

This copies data from the temporary memory to the operator selected with the OPERATOR SELECT buttons.

- * The LCD display will read "FUNCTION 12A
 >>COPY■■■TEMP>>INIT>>RCAL SUBJOB 2
 :Extract temporary OP data ?".

****The SAVE TEMPORARY OPERATOR DATA process**

- (a) Enter the FUNCTION mode and press PERFORMANCE & VOICE button 4 to call the "■■■TEMP" display.
- (b) Sub-Job 1 (TEMPORARY SAVE OP DATA) is automatically selected.

Fig. 74. copy Operator Function

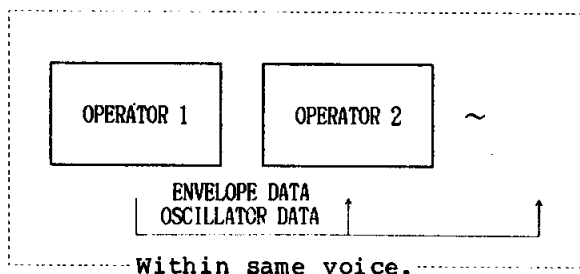
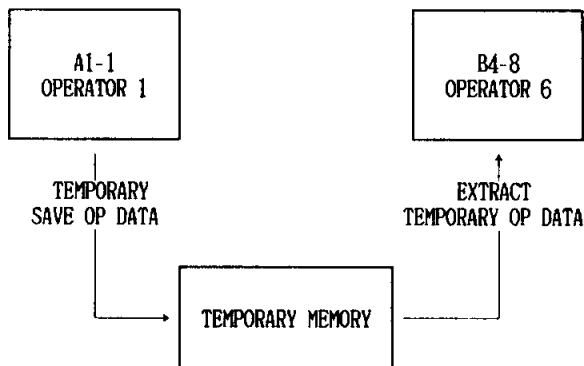

Fig. 75. Save Temporary Operator Function



- (c) Use the OPERATOR SELECT buttons to select the operator from which the data is to be copied.
 - (d) Press the DATA ENTRY YES button to copy the data to the temporary memory. "+++ " will appear following "?" on the display.
 - (e) Press the DATA ENTRY NO button to switch to Sub-Job 2 (EXTRACT TEMPORARY OP DATA).
 - (f) Select the copy destination operator using the OPERATOR SELECT buttons.
 - (g) Press the DATA ENTRY YES key to copy the data.
 - (h) All EDIT mode parameters on the LED display switch from those originally in the destination operator to those of the origin operator.
- * Sub-Job 1 and 2 can be performed separately. Steps (a) through (d) perform Sub-Job 1, and steps (a), (e) and (h) perform Sub-Job 2.

Job 3 - INITIALIZE MEMORY

This function sets all VOICE or PERFORMANCE parameters in a voice to an initial state from which an entirely new voice can be created. 2 Sub-Jobs are included: INITIALIZE VOICE and INITIALIZE PERFORMANCE.

- * INITIALIZE VOICE and INITIALIZE PERFORMANCE can be called alternately by pressing the DATA ENTRY NO key.
- * Not all parameters are set to 0. The parameters are set for the easiest voice creation.

***INITIALIZE VOICE (Sub-Job 1)**

This initializes the VOICE parameters. VOICE parameters in the VOICE EDIT BUFFER are initialized, rather than initializing an actual VOICE MEMORY position.

- * To save a voice which has been created using the INITIALIZE VOICE function, it must be stored into the VOICE MEMORY. →P.53
- * The EDIT switch lights automatically when INITIALIZE VOICE is called. The EDIT mode is entered simply by turning OFF any FUNCTION switches, and editing can be commenced.
- * The LCD display will read "FUNCTION 12A
 >>COPY>>TEMP■■■INIT>>RCAL SUBJOB 1
 :Initialize voice edit-buffer?".

***INITIALIZE PERFORMANCE (Sub-Job 2)**

This initializes the PERFORMANCE parameters. PERFORMANCE parameters in the PERFORMANCE EDIT BUFFER are initialized, rather than those in an actual PERFORMANCE MEMORY location. →P.44 (INITIALIZE PERFORMANCE DATA LIST)

- * The LCD display will read "FUNCTION 12A
 >>COPY>>TEMP■■■INIT>>RCAL SUBJOB 2
 :Initialize perform edit-buff?".
- * To save a voice which has been created using the INITIALIZE PERFORMANCE function, it must be stored into the PERFORMANCE MEMORY. →P.53

****The INITIALIZE MEMORY process**

- (a) Enter the FUNCTION mode and press PERFORMANCE & VOICE button 4 to call

- the "INIT" display.
- (b) Sub-Job 1 (INITIALIZE VOICE) is automatically selected.
- (c) Press the DATA ENTRY YES button to begin the initialize operation. "Voice buff. now initialized!" will appear following "SUBJOB 1" on the display.
- (d) Press the DATA ENTRY NO button to switch to Sub-Job 2 (INITIALIZE PERFORMANCE).
- (e) Press the DATA ENTRY YES button to begin the initialize operation. "Performance buff. now initialized!" will appear following "SUBJOB 2" on the display.
- * Sub-Job 1 and 2 can be performed separately. Steps (a) through (c) perform Sub-Job 1, and steps (a), (d) and (e) perform Sub-Job 2.

◆ INITIALIZE VOICE DATA LIST

ALGORITHM	PATTERN	1
	FEEDBACK	0
OSCILLATOR	MODE	OP 1~OP 6 F.RATIO
	DETUNE	OP 1~OP 6 0
	FREQUENCY COARSE	OP 1~OP 6 1.00
	FREQUENCY FINE	OP 1~OP 6 1.00
EG	RATE 1~4	OP 1~OP 6 99
	LEVEL 1~3	OP 1~OP 6 99
	LEVEL 4	OP 1~OP 6 0
PITCH EG	RATE 1~4	99
	LEVEL 1~4	50
LEVEL SCALING	BREAK POINT	OP 1~OP 6 0 = A-1
	CURVE L · R	OP 1~OP 6 -LIN
	DEPTH L · R	OP 1~OP 6 0
RATE SCALING		OP 1~OP 6 0
SENSITIVITY	KEY VELOCITY	OP 1~OP 6 0
	AMPL. MODULATION	OP 1~OP 6 0
OPERATOR OUTPUT LEVEL		OP 1 99
		OP 2~OP 6 0
LFO	WAVE	TRIANGLE
	SPEED	35
	DELAY	0
	PMD	0
	PMS	3
	AMD	0
	KEY-SYNC	ON
OSCILLATOR KEY SYNC		ON
TRANSEPOSE		+00=C3
VOICE NAME		□=BLANK

◆ INITIALIZE PERFORMANCE DATA LIST

DUAL MODE DETUNE		0
POLY/MONO		POLY
SOURCE SELECT		0 = INT.
PITCH BEND	RANGE	5
	STEP	0

PORTAMENTO	PORTAMENTO / GLISSANDO	PORT
	PORTAMENTO MODE	RETAIN
	PEDAL ASSIGN	ON
	TIME	0
OUTPUT LEVEL ATTENUATE		7
PROG. OUTPUT ASSIGN		OFF
SUSTAIN PEDAL ASSIGN		ON
MODULATION WHEEL	SENSITIVITY	15
	ASSIGN	001 = PMD
FOOT CONTROLLER	SENSITIVITY	0
	ASSIGN	000
BREATH CONTROLLER	SENSITIVITY	0
	ASSIGN	000
AFTER TOUCH	SENSITIVITY	0
	ASSIGN	000
SPLIT POINT		C3
KEY SHIFT		+00=C3
PERFORMANCE NAME		□=BLANK
KEY INDIV. AFTER	TOTAL SENSITIVITY	0
	DECAY RATE	99
	RELEASE RATE	99
	DEPTH	OP 1~OP 6 0

JOB 4 - RECALL EDIT BUFF

If voice parameters in the VOICE EDIT BUFFER are accidentally lost during an editing process, this function permits recalling the lost data to the VOICE EDIT BUFFER.

- * If a different VOICE MEMORY button is pressed while in the COMPARE mode, data in the buffer is lost.
- * If the EDIT mode is exited and the INITIALIZE VOICE function is called, data in the buffer is replaced by the initial voice data.
- * The VOICE EDIT BUFFER incorporates a second utility memory in which the lost data is retained. The RECALL EDIT BUFF function recalls this data to the main VOICE EDIT BUFFER (fig. 76). The data will be completely lost, however, if two accidental data erasures occur in a row before using the RECALL EDIT BUFF function.
- * Data lost from the PERFORMANCE EDIT BUFFER can not be recalled.
- * The LCD display will read "FUNCTION 12A >>COPY>>TEMP>>INIT■RCAL Recall previous edit buffer data OK?"

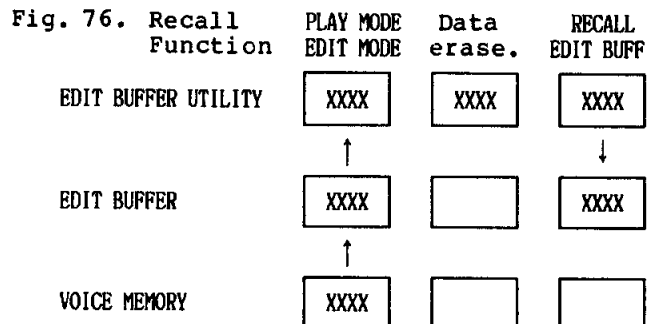

****The RECALL EDIT BUFFER process**

- (a) Enter the FUNCTION mode and press PERFORMANCE & VOICE button 4 to call the "■■RCAL" display.
- (b) Press the DATA ENTRY YES button to perform the RECALL operation.
- (c) The FUNCTION mode is automatically exited and the EDIT mode is entered.

(16) PERFORMANCE & VOICE 5 (F13)

This includes functions related to the cartridge memory. 3 Jobs are incorporated: SAVE TO CARTRIDGE, LOAD FROM CARTRIDGE and CHANGE FORMAT CART.

Job 1 - SAVE TO CARTRIDGE

This saves all VOICE or PERFORMANCE memory locations to an external cartridge at once (fig. 77). 3 Sub-Jobs are included: SAVE ALL VOICE A, SAVE ALL VOICE B and SAVE PERFORMANCE.

- * SAVE TO CARTRIDGE is only possible with a RAM cartridge.
- * The SAVE ALL VOICE A, SAVE ALL VOICE B and SAVE PERFORMANCE functions can be called sequentially by pressing the DATA ENTRY NO button.

***SAVE ALL VOICE A (Sub-Job 1)**

All channel A VOICE MEMORY data (VOICE MEMORY A1-1 through A4-8) is save to a VOICE RAM CARTRIDGE (FORMAT = 00) inserted in cartridge slot A.

- * The LCD display will read "FUNCTION 13 ■■SAVE>>LOAD>>FORM Save all voices. from INT-A into EXT-A?".

***SAVE ALL VOICE B (Sub-Job 2)**

All channel B VOICE MEMORY data (VOICE MEMORY B1-1 through B4-8) is save to a RAM cartridge inserted in cartridge slot B.

- * The LCD display will read "FUNCTION 13 ■■SAVE>>LOAD>>FORM Save all voices. from INT-B into EXT-B?".

***SAVE PERFORMANCE (Sub-Job 3)**

All internal PERFORMANCE MEMORY data (PERFORMANCE MEMORY P1-1 through P8-8) is save to a PERFORMANCE RAM CARTRIDGE (FORMAT

Fig. 77. Save/Load Function

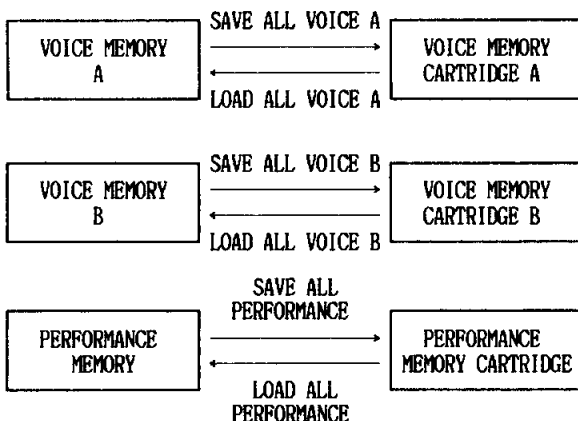

= 01) inserted in cartridge slot A.

- * The LCD display will read "FUNCTION 13 ■■SAVE>>LOAD>>FORM Save performance memories into EXT-A?".

****The SAVE TO CARTRIDGE process**

- (a) Switch to the FUNCTION mode, and press the PERFORMANCE & VOICE button 5 to call the "■■SAVE" display.
- (b) The SAVE ALL VOICE A function is automatically selected. SAVE ALL VOICE B and SAVE PERFORMANCE can be selected sequentially using the DATA ENTRY NO button.

- * If a YES/NO response to the control prompts in steps (c) through (g) below is entered incorrectly, the process will revert to step (b) above and the next Sub-Job will be selected.

- (c) Press the DATA ENTRY YES button to continue on to the following operations.

- (d) "Change your mind?" will appear on the lower row of the display. Press the DATA ENTRY NO button to continue.

- (e) "Insert Cartridge in A" will appear on the lower row of the display. Insert the cartridge.

- * When using SAVE ALL VOICE A or SAVE ALL VOICE B a cartridge formatted for VOICE MEMORY (FORMAT = 00) must be inserted.

- When using SAVE PERFORMANCE, a cartridge formatted for PERFORMANCE MEMORY (FORMAT = 01) must be inserted.

- As shipped, RAM cartridges are initially formatted for VOICE MEMORY (FORMAT = 00). Use the CHANGE CART.

- FORMAT function to change to the PERFORMANCE MEMORY format as required. -P.46

- * When using SAVE ALL VOICE B, insert the cartridge into cartridge slot B.

- * RAM cartridges have a memory protect switch. Be sure to turn this switch OFF before inserting the cartridge.

- (f) Press the DATA ENTRY YES button to go on to the next step.

- (g) The display will read "Ready ?". Press the DATA ENTRY YES button again to begin the actual SAVE TO CARTRIDGE operation.

- * If the YES button is pressed and a cartridge is not inserted, the "***ERROR** Cartridge not ready!" message will appear.

- * If saving is attempted to a cartridge with the wrong format, the "***ERROR** Cartridge format conflict!" message will appear.

- * If save is attempted to a ROM cartridge, or to a RAM cartridge with the memory protect switch ON, the "***ERROR** Cartridge write protected!" message will appear.

- (h) When the SAVE operation is initiated, the "Writing >****" message will appear.

- (i) When the SAVE operation is complete the "****Save completed!****" message will appear.

- * If the cartridge is removed before the SAVE operation is complete, the "***ERROR** Cartridge read/write error!" message will appear. In this case, only a portion of the data will have

been saved.

- * After a successful SAVE operation, be sure to turn the cartridge memory switch back ON to prevent accidental erasure.

Job 2 - LOAD FROM CARTRIDGE

This loads all VOICE or PERFORMANCE memory data from an external cartridge into the internal memory at once (fig. 93). 3 Sub-Jobs are included: LOAD ALL VOICE A, LOAD ALL VOICE B and LOAD PERFORMANCE.

- * The LOAD ALL VOICE A, LOAD ALL VOICE B and LOAD PERFORMANCE functions can be called sequentially by pressing the DATA ENTRY NO button.

*LOAD ALL VOICE A (Sub-Job 1)

All channel A VOICE MEMORY data (VOICE MEMORY A1-1 through A4-8) is loaded from a VOICE MEMORY CARTRIDGE inserted in cartridge slot A.

- * The LCD display will read "FUNCTION 13 >>SAVE■■LOAD>>FORM Load all voices. from EXT-A into INT-A?".

*LOAD ALL VOICE B (Sub-Job 2)

All channel B VOICE MEMORY data (VOICE MEMORY B1-1 through B4-8) is loaded from a VOICE MEMORY CARTRIDGE inserted in cartridge slot B.

- * The LCD display will read "FUNCTION 13 >>SAVE■■LOAD>>FORM Load all voices. from EXT-B into INT-B?".

*LOAD PERFORMANCE (Sub-Job 3)

All internal PERFORMANCE MEMORY data (PERFORMANCE MEMORY P1-1 through P8-8) is loaded from a PERFORMANCE MEMORY CARTRIDGE inserted in cartridge slot A.

- * The LCD display will read "FUNCTION 13 >>SAVE■■LOAD>>FORM Load performance memories from EXT-A?".

**The LOAD FROM CARTRIDGE process

- Switch to the FUNCTION mode, and press the PERFORMANCE & VOICE button 6 to call the PROTECT MEMORY WRITE function.
 - Press the DATA ENTRY NO button to turn PROTECT MEMORY WRITE OFF.
 - Press the PERFORMANCE & VOICE switch 5 to call the "■■LOAD" display.
 - The LOAD ALL VOICE A function is automatically selected. LOAD ALL VOICE B and LOAD PERFORMANCE can be selected sequentially using the DATA ENTRY NO button.
- * If a YES/NO response to the control prompts in steps (e) through (i) below is entered incorrectly, the process will revert to step (d) above and the next Sub-Job will be selected.
 - (e) Press the DATA ENTRY YES button to continue on to the following step.
 - (f) "Change your mind?" will appear on the lower row of the display. Press the DATA ENTRY NO button to continue.
 - (g) "Insert Cartridge in A" will appear

on the lower row of the display.

Insert the cartridge.

- * When using LOAD ALL VOICE B, insert the cartridge into cartridge slot B.
- (h) Press the DATA ENTRY YES button to go on to the next step.
- (i) The display will read "Ready?". Press the DATA ENTRY YES button again to begin the actual LOAD FROM CARTRIDGE operation.
- * If the YES button is pressed and a cartridge is not inserted, the "***ERROR** Cartridge not ready!" message will appear.
- * If loading is attempted from a cartridge with the wrong format, the "***ERROR** Cartridge format conflict!" message will appear.
- * If LOAD is attempted with the PROTECT MEMORY WRITE function ON, the "***ERROR** Memory write protected!" message will appear.
- (j) When the LOAD operation is complete the "***Load completed!***" message will appear.

Job 3 CHANGE CART. FORMAT

In the DX1 the same external RAM cartridges are used for VOICE MEMORY and PERFORMANCE MEMORY storage. The CHANGE CART. FORMAT function "labels" the cartridge for either VOICE or PERFORMANCE memory, so the DX1 can recognize the cartridge type and access it properly. When this function is used, all data that was previously in the cartridge is erased.

- * The LCD display will read "FUNCTION 13 >>SAVE>>LOAD■■FORM Format cartridge (A). Type XX to ?? OK?".
- * The format type must be entered as a two-digit value. 00 is for VOICE MEMORY and 01 is for PERFORMANCE MEMORY.
- * Values other than 00 and 01 will be accepted, but the resulting format will be meaningless to the DX1.
- * RAM cartridges are initially formatted for VOICE MEMORY (FORMAT= 00).
- * The format of the supplied ROM cartridges can not be altered.
- * The cartridge to be formatted must be inserted into cartridge slot A.
- * Using the CHANGE CART. FORMAT function completely erases any data that is in the cartridge. Unlike the INITIALIZE MEMORY and CLEAR ALL MEMORY functions, the CHANGE CART. FORMAT function leaves all parameters set at their minimum value.

**The CHANGE CART. FORMAT process

- Insert the RAM cartridge to be formatted into cartridge slot A.
- Be sure to turn the RAM cartridge memory protect switch OFF before inserting the cartridge.
- Switch to the FUNCTION mode and press the PERFORMANCE & VOICE button 5 to call the "■■FORM" DISPLAY.
- The "Type XX" portion of the display will indicate the current format of the inserted cartridge.

- (d) Use the VOICE PARAMETER switches to enter the new format number. This will appear in the "??" portion of the display.
- (e) Press the DATA ENTRY YES button to go on to the next step.
 - * A NO response can not be entered at this point.
 - * If a YES/NO response is entered incorrectly in steps (f)--(i), the FUNCTION mode will be exited and the previous mode will be re-entered.
- (f) The display will read "You lose original data. Are you sure?". Press the DATA ENTRY YES button to confirm.
- (g) The display requests a second confirmation: "New format number is XX. OK?". Press the DATA ENTRY YES button to continue.
 - * "XX" is the new format number.
 - * If a format number is not entered in step (d), the default format number 00 is assumed.
- (h) The cartridge will then read "Execute formatting of cartridge A. OK?".
- (i) Press the YES button to execute the actual formatting process.
 - * If the YES button is pressed and no cartridge is inserted, the "***ERROR** Cartridge not ready!" message will appear.
 - * If formatting of a ROM cartridge is attempted, or the RAM cartridge memory protect switch is ON, the "***ERROR** Cartridge write protected!" message will appear.
- (j) During the formatting process, the display will read "FORMAT >***.....".
- (k) When formatting is completed, the "***Format completed!***" message will appear.
 - * If the cartridge is removed before the format process is completed the "***ERROR** Cartridge read/write error!" message will appear.

(17) PERFORMANCE & VOICE 6 (F14)

This includes the remaining 3 MEMORY MANAGEMENT Jobs: PROTECT MEMORY WRITE, CLEAR ALL MEMORY, and CHECK BATTERY.

Job 1 - PROTECT MEMORY WRITE

When this function is ON, the internal VOICE MEMORY and PERFORMANCE MEMORY are write-protected. The ON/OFF status is set using the DATA ENTRY section.

- * This must be turned OFF before using any STORE function.
- * Must be turned OFF to use the (16) LOAD FROM CARTRIDGE function.
- * PROTECT MEMORY WRITE is automatically turned ON every time power to the DX1 is turned ON.
- * The LCD display will read "FUNCTION 14A ■■■MPRT>>CLR>>BCHK Internal memory write protect XX". "XX" is the ON/OFF status.

Job 2 - CLEAR ALL MEMORY

This function initializes all the internal VOICE MEMORY and PERFORMANCE MEMORY data at once.

- * Using this function completely erases all data in memory and sets all parameters to their initial state. Clearing only the VOICE MEMORY or PERFORMANCE MEMORY, or a specified memory location is not possible.
- * Cartridge data can not be erased using this function.
- * The LCD display will read "FUNCTION 14A >>MPRT■■■CLR>>BCHK Clear all memory?."

**The CLEAR ALL MEMORY process

- (a) Switch to the FUNCTION mode, and use the PERFORMANCE & VOICE button 6 to call the "■■■CLR" display.
- (b) Press the DATA ENTRY YES button to go on to the next step.
 - * If NO is entered, the FUNCTION mode is exited and the previous mode is re-entered.
 - * If a YES/NO response to the control prompts in steps (c) through (g) below is entered incorrectly, the FUNCTION mode is exited and the previous mode is re-entered.
- (c) The display will read "You lose all data. OK?". Press YES to confirm.
- (d) "Change your mind?" will appear on the display. Press the DATA ENTRY NO button to continue.
- (e) "Are you sure ?" will appear on the display. Press YES to confirm and begin the actual CLEAR process.
- (f) When the CLEAR ALL MEMORY operation is complete the "***All memory now erased!***" message will appear.
- (g) If the FUNCTION switch is turned OFF or the DATA ENTRY NO button is pressed, the previous mode is entered.
 - * Another function within the FUNCTION mode can also be selected.

Job 3 - CHECK BATTERY

This function checks the voltage of the battery which backs up the internal VOICE MEMORY and PERFORMANCE MEMORY.

- * The LCD display will read "FUNCTION 14A >>MPRT>>CLR■■■BCHK Check battery XX". "XX" is the battery voltage. Any voltage higher than 2.2 volts is "normal".
- * An exceptionally long-life battery has been used, however, if the battery voltage does drop below 2.2 volts the "***CAUTION*** change battery!" message will be displayed. In this case the battery needs to be replaced. However, a special type of battery is used and replacement MUST BE DONE AT A YAMAHA DEALER. Contact your nearest Yamaha dealer when battery replacement becomes necessary.
- * Battery voltage is greater than 3.0 volts when initially shipped.

5-5 MIDI INFO. CONTROL (fig. 78)

Functions which determine the operation of the rear-panel MIDI connector are incorporated in PERFORMANCE & VOICE switches 7 and 8 on the lower row of the PERFORMANCE MEMORY/FUNCTION section. The MIDI connector

makes it possible to control the DX1 from the YAMAHA KX1 or KX5 Remote Keyboard, mutual control between the DX1 and another keyboard equipped with a MIDI connector, or control the DX1 from a computer or sequencer.

- * The MIDI connector transmits or receives 31,250 bits of information per second and is capable of responding in real time. CHANNEL INFORMATION including key-on, key-off, effect controller and voice memory number data, as well as SYSTEM INFORMATION including voice data, effect data and parameter select status can be handled.
- * The CHANNEL INFORMATION format is compatible with keyboards made by any other manufacturer, so any MIDI standard keyboards, computers or sequencers can be used.
- * SYSTEM INFORMATION includes SYSTEM EXCLUSIVE DATA for transfer of memory data and switching voice parameters, and SYSTEM REAL TIME DATA for remote sequencer control. In particular, SYSTEM EXCLUSIVE DATA is a YAMAHA-only standard: all Yamaha DX series synthesizers and MIDI standard equipment can be used.
- * 16 independent MIDI data channels are incorporated, and each can be independently controlled. When the DX1 is used to control an external piece of equipment, channel 1 is automatically selected. When the DX1 is to receive data from an external source, the (2) SOURCE SELECT function must be used to match the receiving channel in the DX1 with the transmitting channel in the external data source. →P.36
- * The MIDI connectors are provided on the rear panel. Three connectors are provided MIDI OUT, MIDI IN, and MIDI THRU (MIDI THRU outputs the data received at MIDI IN as is) (fig. 79).

Fig. 78. MIDI Information Control

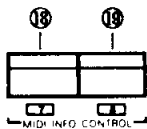
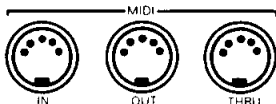

Fig. 79. MIDI Terminals



(18) PERFORMANCE & VOICE 7 (F15)

3 Jobs are provided: MIDI SWITCH, SET STATUS, TRANSMIT DATA.

Job 1 - MIDI SWITCH

This master switch turns the MIDI terminals ON or OFF. The ON/OFF status can be set at the DATA ENTRY section.

- * When ON MIDI data transfer with external equipment is possible.

- * When OFF the MIDI terminals will not function.
- * The MIDI SWITCH can not be turned ON or OFF while a key is pressed.
- * The LCD display will read "FUNCTION 15 ■■MIDI>>STAT>>DUMP MIDI switch XX". "XX" is the ON/OFF status.

Job 2 - SET STATUS

This sets the type of data to be handled. 5 Sub-Jobs are included: BASIC EVENT DATA OUTPUT, OTHER EVENT DATA OUTPUT, SYSTEM EXCLU. COMMUNICATION, OMNI MODE, and PROGRAM CHANGE MODE.

- * The 5 Sub-Jobs can be selected sequentially by pressing the DATA ENTRY NO button.

*BASIC EVENT DATA OUTPUT (Sub-Job 1)

This turns BASIC EVENT DATA (data relating to the keyboard and controllers) transfer via the MIDI connectors ON or OFF.

- * When ON, the data described in (a)--(f) below is transmitted from the MIDI OUT connector when the DX1 is played.
- * This data is generally common to all keyboards compatible with the MIDI system. Due to differences in the features provided on some keyboards, however, complete compatibility can not be guaranteed.
- * The LCD display will read "FUNCTION 15 >>MIDI■■STAT>>DUMP SUBJOB 1: Basic event data output XX". "XX" is the ON/OFF status.
- * The ON and OFF states alternate when the DATA ENTRY YES button is pressed.

**Main BASIC EVENT DATA contents

- (a) KEY ON/OFF: Key timing.
- (b) KEY NUMBER: Which key(s) has been pressed.
- (c) KEY VELOCITY: Initial touch response data.
- (d) SUSTAIN FOOT SW: Sustain ON/OFF.
- (e) PITCH BEND WHEEL: Pitch bend depth data.
- * Transmission: The DX1 transmission channel is 1, so the receiving instrument or equipment must be set up to receive on channel 1.
- * Reception: The (2) SOURCE SELECT function can be used to match the DX1 receiving channel with the transmission channel of the external instrument or equipment, or OMNI MODE (Sub-Job 4) can be set for continuous reception.
- (f) SYSTEM REAL TIME DATA: Remote sequence.
- * Transmission: When the DX1 is used with a sequencer or computer, the SYSTEM REAL TIME DATA permits sending START/PAUSE/STOP commands to the external equipment from the DX1.
- * This is actually included in the SYSTEM INFORMATION, but can be turned ON/OFF using BASIC EVENT DATA OUTPUT.
- * Remote sequence commands are sent using the (19) REMOTE SEQUENCE function. →P.51
- * Reception: Ignored. This has no effect on the DX1.

*OTHER EVENT DATA OUTPUT (Sub-Job 2)

This turns OTHER EVENT DATA (data not included in BASIC EVENT DATA, relating to performance functions, memory selection, etc.) transfer via the MIDI connectors ON or OFF.

- * When ON, the data described in (g)--(o) below is transmitted from the MIDI OUT connector when the DX1 is played.
- * This data is generally common to all keyboards compatible with the MIDI system. Due to differences in the features provided on some keyboards, however, complete compatibility can not be guaranteed.
- * The LCD display will read "FUNCTION 15 >>MIDI■■STAT>>DUMP SUBJOB 2: Other event data output XX". "XX" is the ON/OFF status.
- * The ON and OFF states alternate when the DATA ENTRY YES button is pressed.

**Main OTHER EVENT DATA contents

- (g) MODULATION WHEEL: LFO modulation and EG BIAS depth.
- (h) FOOT CONTROLLER: LFO modulation and EG BIAS depth.
- (i) AFTER TOUCH: LFO modulation and EG BIAS depth.
- (j) BREATH CONTROLLER: LFO modulation and EG BIAS depth.
- (k) PORTAMENTO SLIDER: Portamento time.
- (l) PORTAMENTO FOOT SW: Portamento ON/OFF.
- (m) PROGRAM CHANGE: VOICE NUMBER or PERFORMANCE NUMBER selection.
- (n) DATA ENTRY SLIDER: EDIT/FUNCTION mode input data.
- (o) +/- SW: EDIT/FUNCTION mode input data.
- * Transmission: The DX1 transmission channel is 1, so the receiving instrument or equipment must be set up to receive on channel 1.
- * Whether a VOICE MEMORY number or a PERFORMANCE MEMORY number is sent in PROGRAM CHANGE is selected using Sub-Job 5 PROGRAM CHANGE MODE.
- * Reception: The (2) SOURCE SELECT function can be used to match the DX1 receiving channel with the transmission channel of the external instrument or equipment.
- * VOICE numbers can be received in the PLAY and FUNCTION modes, PERFORMANCE numbers can be received in the PLAY mode only, and DATA ENTRY +/- and slider data can be received in the EDIT and FUNCTION modes.
- * MIDI receiving channel is included in the PERFORMANCE MEMORY data. When receiving a PERFORMANCE MEMORY NUMBER, if a PERFORMANCE MEMORY with a different receiving channel number is selected, reception becomes impossible. This will not happen if the receiving side is set to the OMNI mode.

*SYSTEM EXCLU. COMMUNICATION (Sub-Job 3)

This turns transfer of data exclusive to

Yamaha DX-series synthesizers and MIDI standard equipment ON or OFF. →P.66

- * When ON, transfer of the data described in (p)--(t) below is possible.
- * MEMORY MANAGEMENT and MIDI INFO. CONTROL data parameters can not be transferred using the MIDI system (except for OMNI MODE).
- * The LCD display will read "FUNCTION 15 >>MIDI■■STAT>>DUMP SUBJOB 3: System exclu. communication XX". "XX" is the ON/OFF status.
- * The ON and OFF states alternate when the DATA ENTRY YES button is pressed.
- * Transmission: The DX1 transmission channel is 1, so the receiving instrument or equipment must be set up to receive on channel 1.
- * Reception: The (2) SOURCE SELECT function can be used to match the DX1 receiving channel with the transmission channel of the external instrument or equipment.

** Main SYSTEM EXCLUSIVE DATA contents

- (p) ONE BULK DATA: VOICE EDIT BUFFER and PERFORMANCE EDIT BUFFER data.
- * VOICE EDIT BUFFER and PERFORMANCE EDIT BUFFER data can be output from the MIDI OUT terminal. The data content transmission procedure is given below. However, PERFORMANCE EDIT BUFFER data can only be received by another DX1. →P.74
- * Press a VOICE MEMORY or PERFORMANCE MEMORY button while holding the DATA ENTRY YES button: the called memory contents is output.
- * Use the INITIALIZE MEMORY function: initialized voice data is output.
- * Use the RECALL EDIT BUFF function: the recalled data is output.
- * Reception: Data received via MIDI IN is stored in the VOICE EDIT BUFFER.
- (Q) 32 VOICE BULK DATA: The entire contents of one VOICE MEMORY channel.
- * Transmission: one entire channel of VOICE MEMORY is transmitted from the DX1. TRANSMIT DATA (Job 3) is used to initiate the transmission. →P.50
- * Reception: This is the same function as (16) LOAD FROM CARTRIDGE (Sub-Job 1, 2). The data received from the transmitting instrument or equipment is stored directly into the VOICE MEMORY.
- * In the PLAY or EDIT mode, the upper row of the display will read "<<MIDI>>" when reception is complete.
- * In the FUNCTION mode, the lower row of the display will read "Received bulk data thru MIDI" when reception is complete.
- * In the STORE mode, the "***MIDI ERROR** RX full!" display will appear and reception will be terminated.
- * If a reception error occurs, the "***MIDI ERROR** check-sum error!" message will appear.
- * If PROTECT MEMORY WRITE is ON, the "***MIDI ERROR** Memory protected!" display will appear.
- (r) 64 PERFORMANCE BULK DATA: All 64 PERFORMANCE MEMORY positions are transferred.

- * **Transmission:** All PERFORMANCE MEMORY data is transmitted at once. TRANSMIT DATA (Job 3) is used to initiate the transmission. However, this data can only be received by a DX1. →P.75
 - * **Reception:** This is the same function as LOAD FROM CARTRIDGE. The data received from the transmitting instrument or equipment is stored directly in the PERFORMANCE MEMORY.
 - * The reception completed displays and error displays are the same as for (q) above.
- (s) **EDIT PARAMETER CHANGE: VOICE parameter data.**
- * **Transmission:** Switching to the EDIT mode and other VOICE parameter operations are transmitted in real time. →P.75
 - * **Data entered at the DATA ENTRY section can be transmitted if Sub-Job 2 is ON.**
 - * **Reception:** The EDIT mode is called and VOICE parameters are accessed according to the operation of the external instrument or equipment.
- (t) **PERFORMANCE MEMORY PARAMETER CHANGE: PERFORMANCE MEMORY parameter data.**
- * **Transmission:** Switching to the FUNCTION mode and other FUNCTION parameter operations are transmitted in real time. This data can only be received by a DX1. →P.75
 - * **Data entered at the DATA ENTRY section can be transmitted if Sub-Job 2 is ON.**
 - * **Reception:** The FUNCTION mode is called and FUNCTION parameters are accessed according to the operation of the transmitting DX1.

* **OMNI MODE (Sub-Job 4)**

This permits MIDI reception on all channels. Channels A and B are set independently (fig. 80).

- * When ON all MIDI receiving channels are active regardless of the setting of SOURCE SELECT (2).
- * The LCD display will read "FUNCTION 15A >>MIDI■■STAT>>DUMP SUBJOB 4: OMNI mode XX". "XX" is the ON/OFF status.
- * The ON and OFF states alternate when the DATA ENTRY YES button is pressed.
- * The OMNI mode ON/OFF status can be transmitted as in (t) of SYSTEM EXCLU. COMMUNICATION, above, when OTHER EVENT DATA OUTPUT is ON.

* **PROGRAM CHANGE MODE (Sub-Job 5)**

Selects the contents (VOICE NUMBER/PERFORMANCE NUMBER) of the OTHER EVENT DATA PROGRAM CHANGE transmission/reception.

Fig. 80. Omni Mode

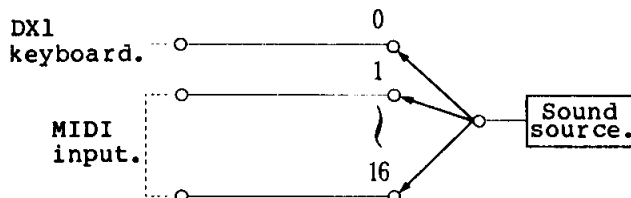

- * The VOICE and PERFORMANCE modes are alternately selected by pressing the DATA ENTRY YES button (pressing the NO button selects the Sub-Job number).
- * The LCD display will read "FUNCTION 15 >>MIDI■■STAT>>DUMP SUBJOB 5: Prog. change mode XX". "XX" is the VOICE/PERFORMANCE status.

Job 3 - TRANSMIT DATA

This function initiates actual transmission of VOICE MEMORY data or PERFORMANCE MEMORY data as in Job 2 SYSTEM EXCLU. COMMUNICATION. 3 Sub-Jobs are included: DUMP ALL VOICE IN BANK A, DUMP ALL VOICE IN BANK B, and DUMP ALL PERFORMANCE DATA (fig. 81).

- * Transmission will function only if SYSTEM EXCLU. COMMUNICATION of Job 2 is ON.

* **DUMP ALL VOICE IN BANK A (Sub-Job 1)**

All 32 VOICE MEMORY position of one channel are transmitted, and loaded into the corresponding channel VOICE MEMORY of the receiver.

- * Press the DATA ENTRY YES button to begin transmission (pressing NO selects another Sub-Job).
- * The channel displayed on the LCD display is transmitted. The channel can be switched using the VOICE MEMORY switches.
- * The LCD display will read "FUNCTION 15 >>MIDI>>STAT■■DUMP SUBJOB 1: Dump all voice in bank A?".

* **DUMP ALL VOICE IN BANK B (Sub-Job 2)**

All 32 VOICE MEMORY position of one channel are transmitted, and loaded into the corresponding channel VOICE MEMORY of the receiver.

- * Press the DATA ENTRY YES button to begin transmission (pressing NO selects another Sub-Job).
- * The channel displayed on the LCD display is transmitted. The channel can be switched using the VOICE MEMORY switches.
- * The LCD display will read "FUNCTION 15 >>MIDI>>STAT■■DUMP SUBJOB 2: Dump all voice in bank B?".

Fig. 81. Transmit Data Function.

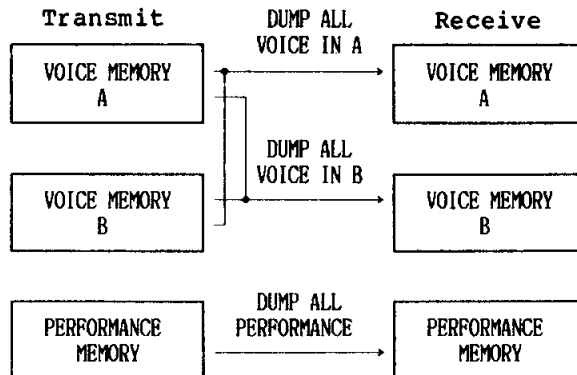

***DUMP ALL PERFORMANCE DATA (Sub-Job 3)**

All 64 PERFORMANCE MEMORY positions are transmitted, and loaded into the PERFORMANCE MEMORY of the receiver.

- * Press the DATA ENTRY YES button to begin transmission (pressing NO selects another Sub-Job).
- * The LCD display will read "FUNCTION 15 >>MIDI>>STAT DUMP SUBJOB 3: Dump all performance data?".

****The TRANSMIT DATA process**

- (a) Switch to the FUNCTION mode.
- (b) Select Job 2 SET STATUS with PERFORMANCE & VOICE switch 7.
- * Sub-Job 1 BASIC EVENT DATA is automatically selected.
- (c) Press the DATA ENTRY NO button twice to call Sub-Job 3, SYSTEM EXCLU. COMMUNICATION.
- (d) Press the DATA ENTRY YES button to turn SYSTEM EXCLUSIVE COMMUNICATION ON.
- (e) Call Job 3, TRANSMIT DATA.
- * Sub-Job 1, DUMP ALL VOICE IN BANK A is automatically selected.
- * Press the DATA ENTRY NO button to select Sub-Job 2 (DUMP ALL VOICE IN BANK B) or Sub-Job 3 (DUMP ALL PERFORMANCE DATA).
- (f) Press the DATA ENTRY YES button to begin transmission.
- * If transmission is attempted while Job 1 MIDI SWITCH is OFF, the "***MIDI ERROR** MIDI switch off!" message will appear.
- * If Job 2 SYSTEM EXCLU. COMMUNICATION is OFF the "***MIDI ERROR** System ex. off!" message will appear.
- * If OTHER EVENT DATA OUTPUT of the receiving instrument is ON, the data and control status of the receiver will

be altered according to the transmitted data. If the receiver FUNCTION mode SOURCE SELECT, MIDI ON/OFF or OMNI MODE are ON when the YES command is given, the receiver may turn OFF, terminating reception.

- (g) During transmission--approx. 1.5 seconds--"BUSY!" will appear on the display.
- * BASIC EVENT DATA or OTHER EVENT DATA transmission will be terminated if the "BUSY!" display is ON.

(19) PERFORMANCE & VOICE 8 (F16)

A single Job--REMOTE SEQUENCE--is incorporated here.

Job 1 - REMOTE SEQUENCE

When the DX1 is used with a sequencer or computer, this function permits sending START/PAUSE/STOP commands to the external equipment from the DX1.

- * A DATA ENTRY YES input sends the START command.
- * Pressing the DATA ENTRY NO button once sends the PAUSE command.
- * Pressing the DATA ENTRY NO button twice in succession sends the STOP command.
- * The display will read "FUNCTION 16 ■■SEQ Sequence contrl NO=pause > stop, YES = start. The cursor points to the current START, PAUSE or STOP command.
- * This is actually included in the SYSTEM INFORMATON, but can be turned ON/OFF using BASIC EVENT DATA OUTPUT. →P.73
- * If the MIDI switch ON/OFF or OMNI MODE are OFF, and the receiving channel is not matched to the sequencer with the (2) SOURCE SELECT function, the sequencer may start, but the sequence signal will not be received by the DX1.